

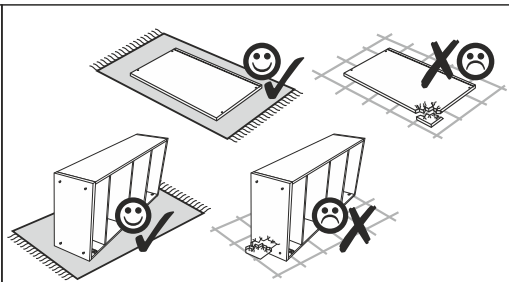

Installation manual

SHELVING 1D2S

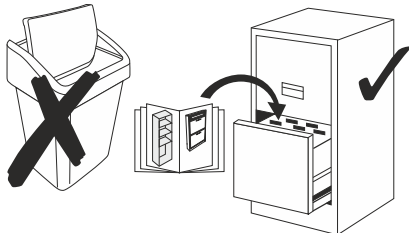
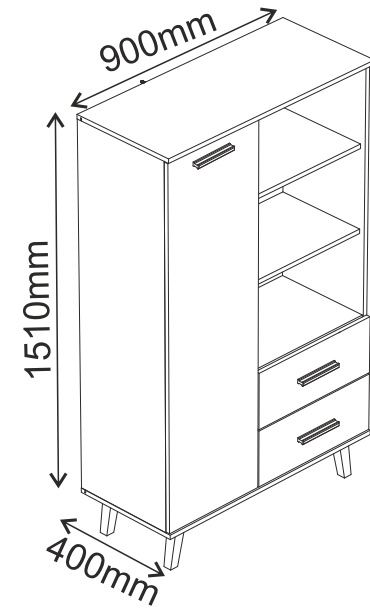
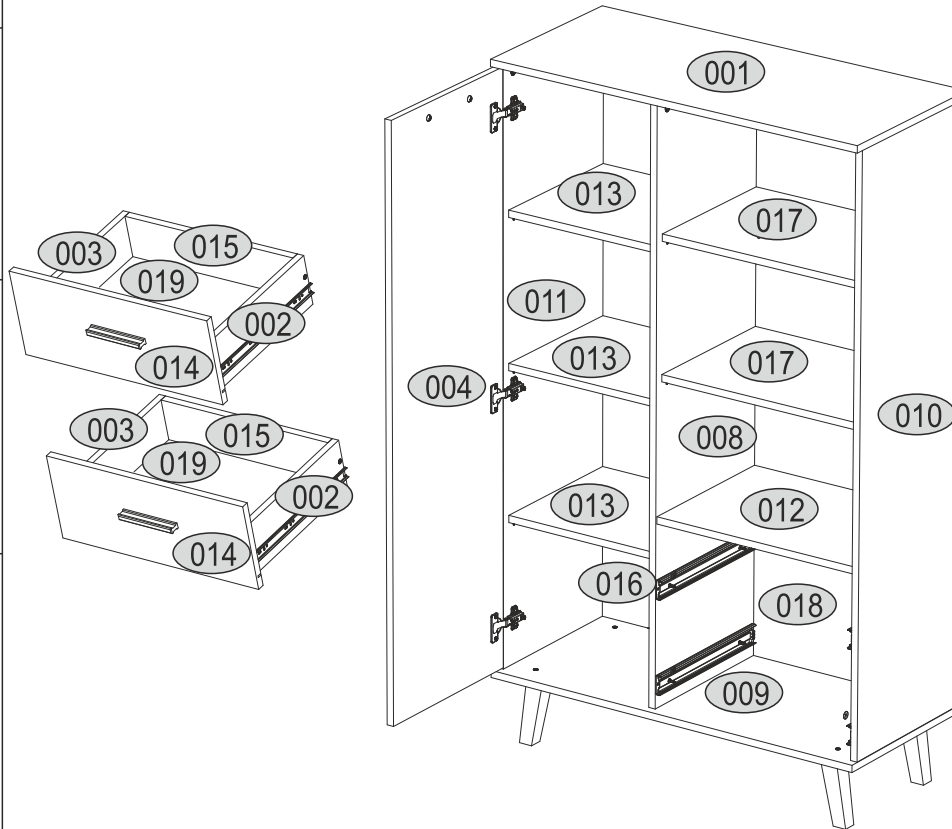
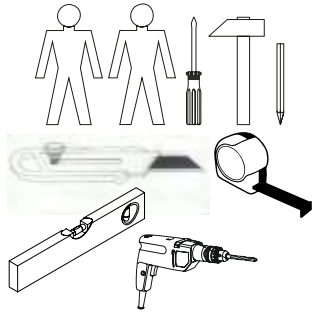
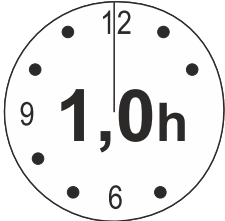

Code	Dimensions			Package
001	900	400	16	1 / 2
002	350	120	16	2 / 2
003	350	120	16	2 / 2
004	1322	392	16	1 / 2
008	1328	360	16	1 / 2
009	900	400	16	1 / 2
010	1328	380	16	2 / 2
011	1328	380	16	2 / 2
012	484	357	16	1 / 2
013	366	340	16	3 / 2
014	500	208	16	2 / 2
015	427	120	16	2 / 2
016	1346	383	3	1 / 2
017	484	340	16	2 / 2
018	1346	500	3	2 / 2
019	352	445	3	2 / 2
accessories				1 / 2

Accessories:

<p>x3 a144</p> 	<p>x3 b119</p> 	<p>x3 c57</p> 	<p>x14 e1</p> <p>Ø7x50mm</p> 
<p>x14 s1</p> 	<p>x36 f1</p> <p>Ø8x30mm</p> 	<p>x6 p9</p> 	<p>x1 z1</p> 
<p>x14 r16</p> 	<p>x42 p25</p> 	<p>x18 s2</p> 	<p>x20 d18</p> 
<p>x14 r1</p> 	<p>x2 lb-350</p> 	<p>x1 p17</p> 	<p>x2 n260</p> 
<p>x8 l2</p> 	<p>x1 n14</p> 	<p>x1 f3</p> 	<p>x4 k88</p> 

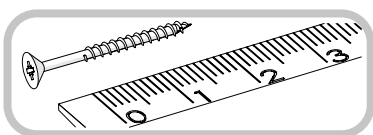

1

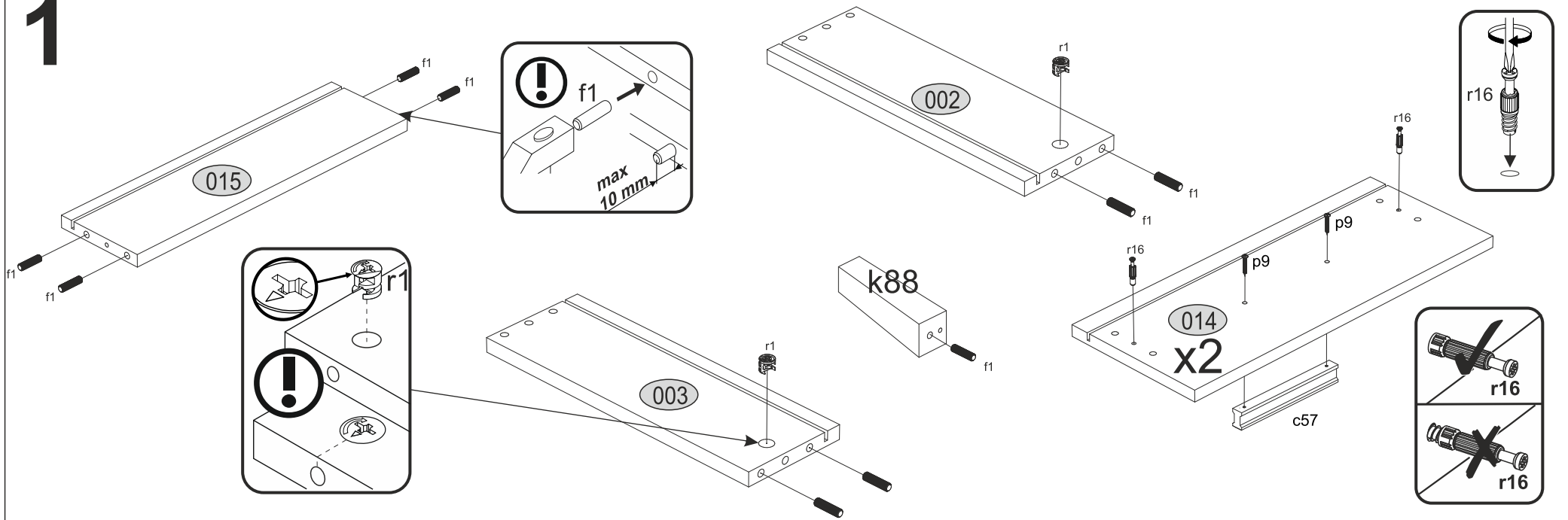

2

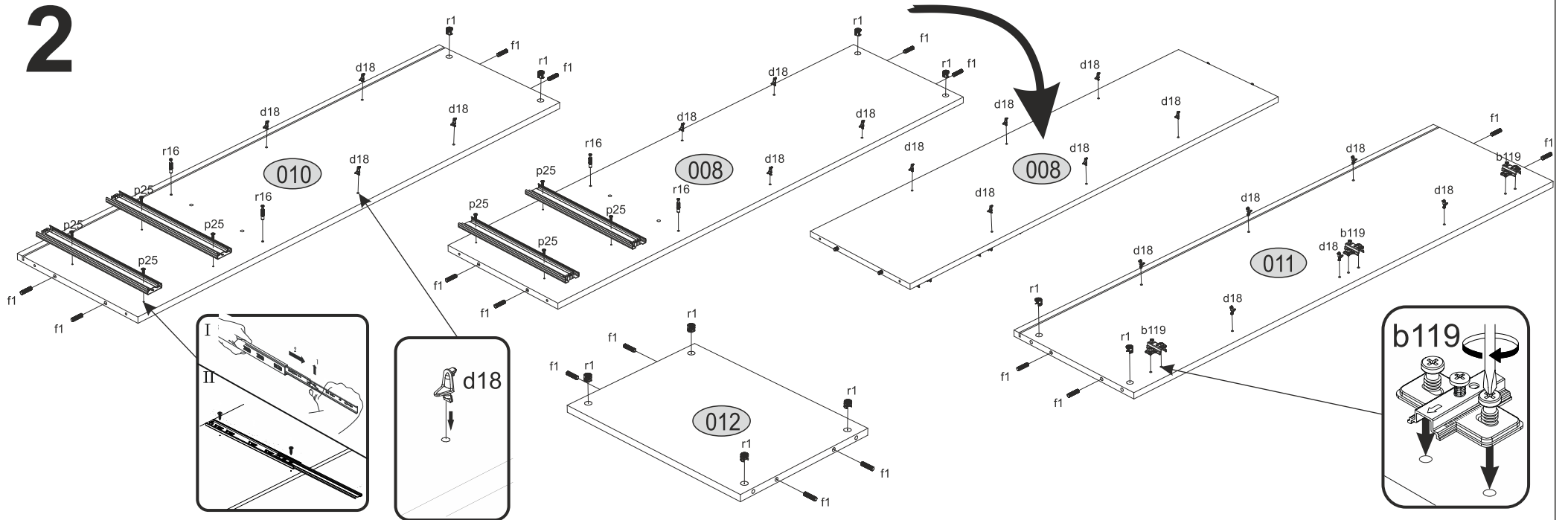

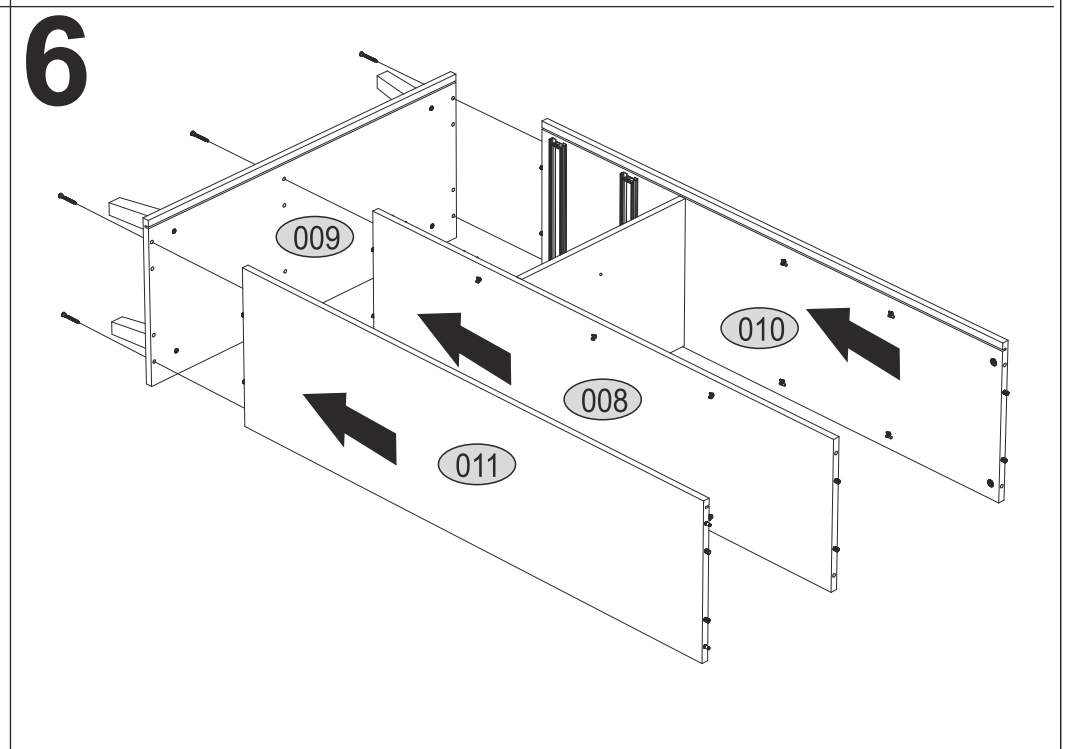
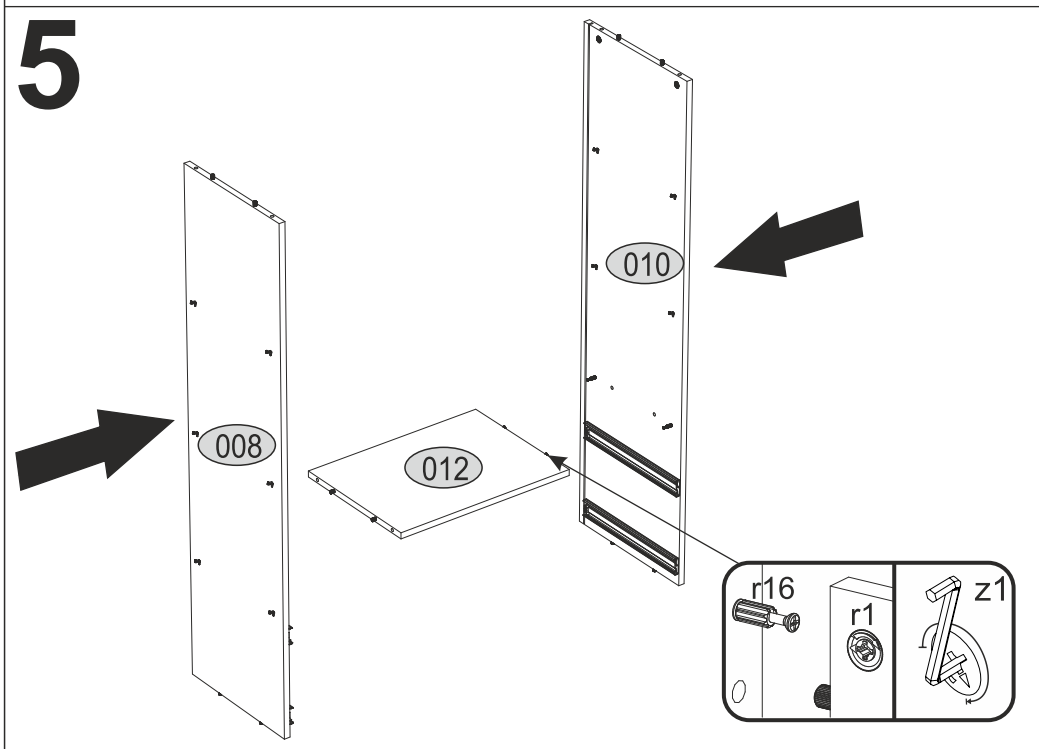
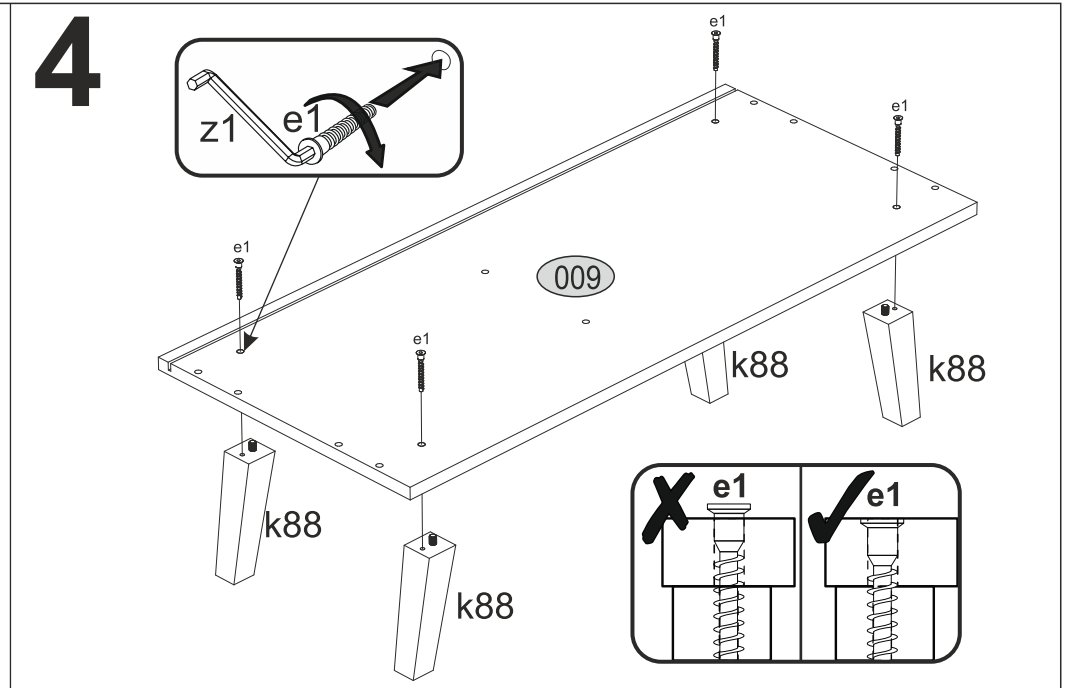
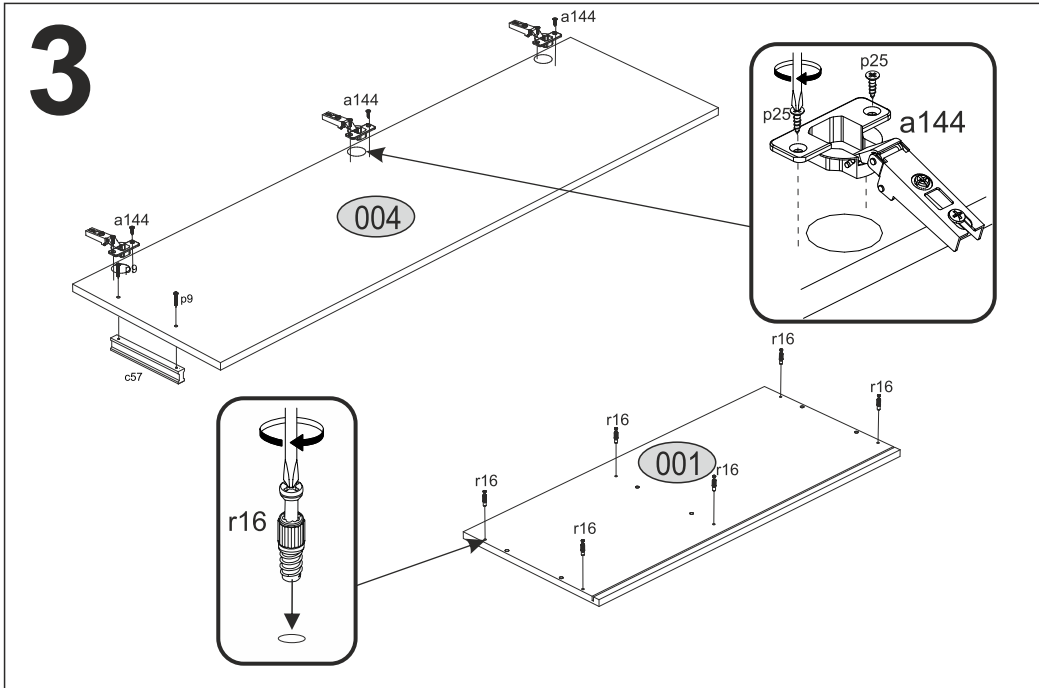

7

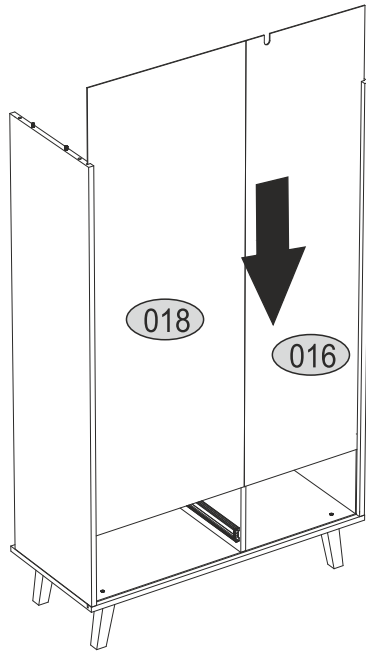

8

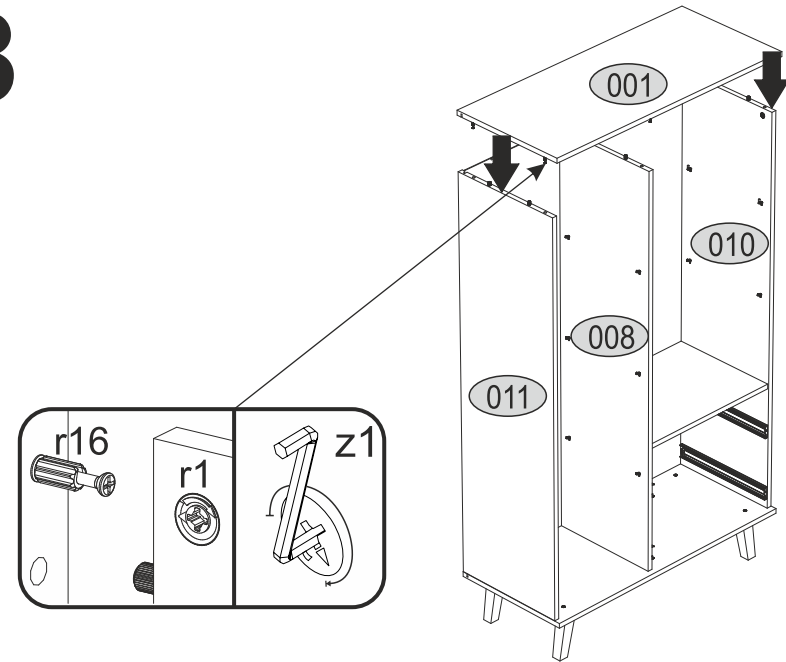

9

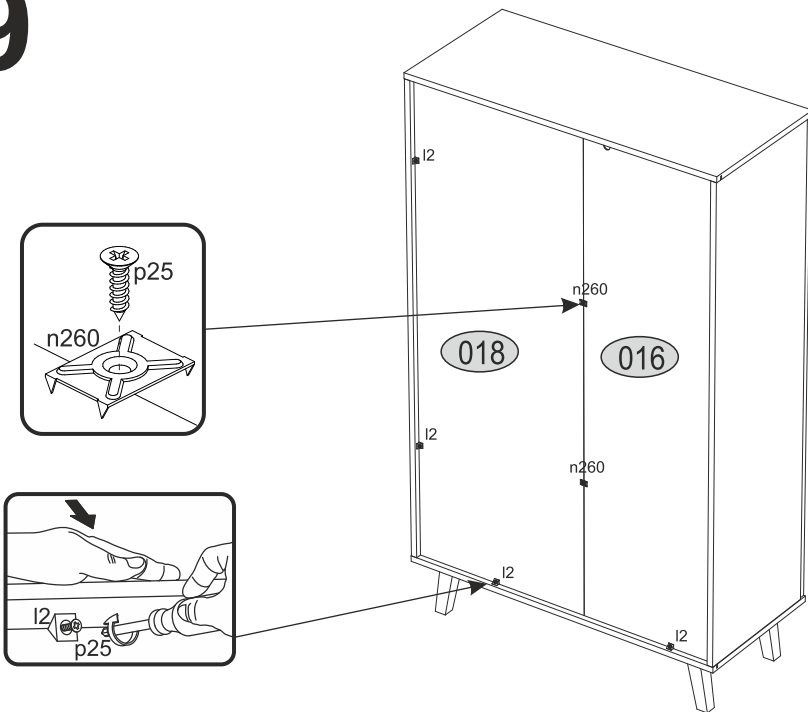

10

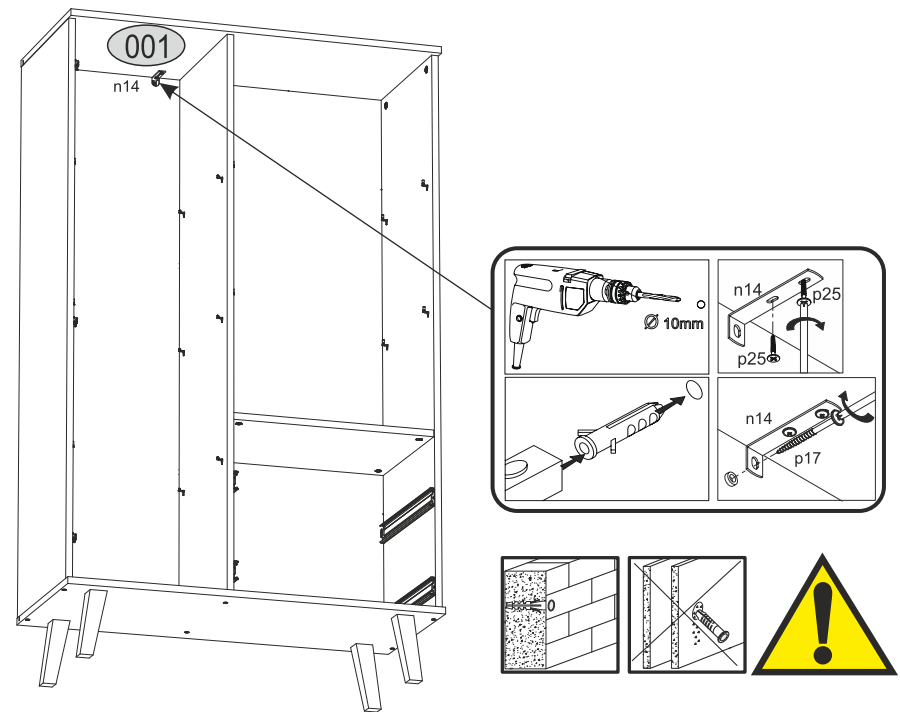

11

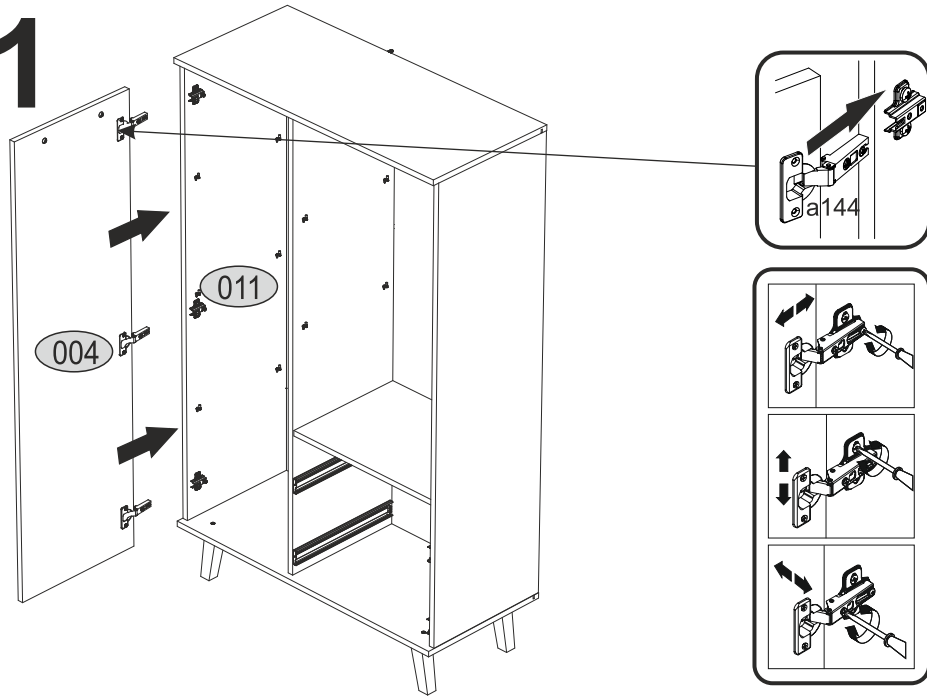

12

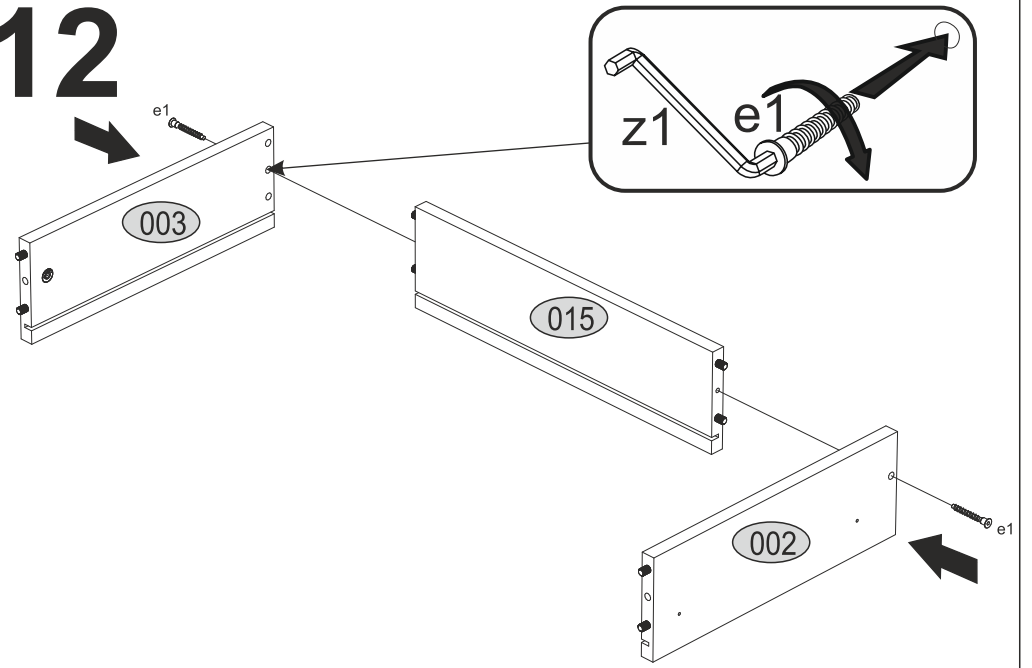

13

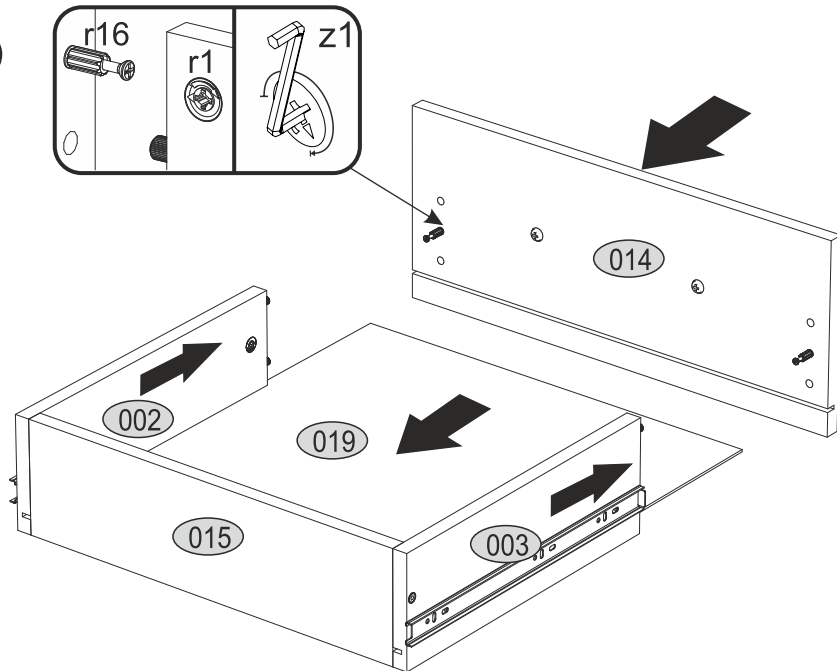

14

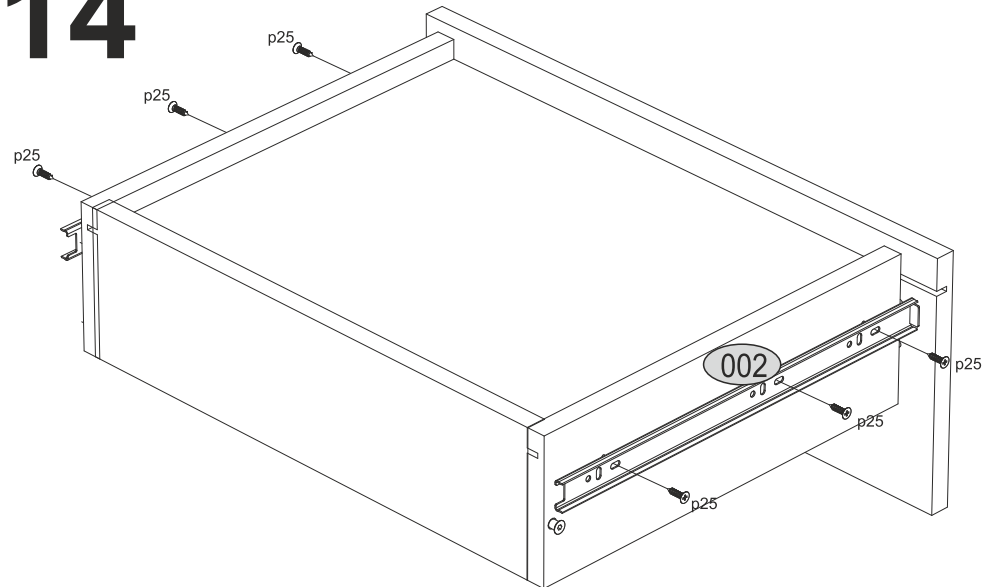

15

