

# Juliet Nightstand 2S

37/50/35

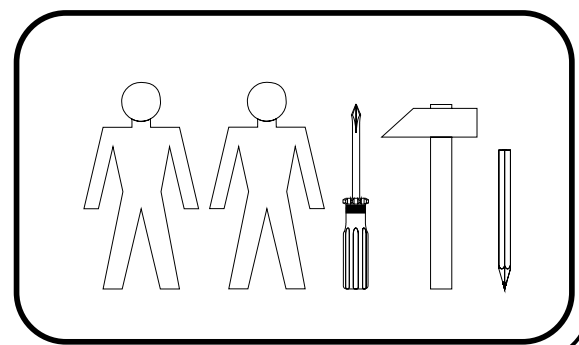

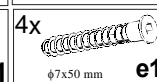
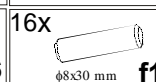
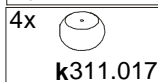
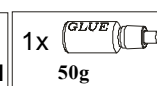
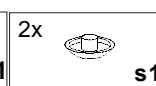
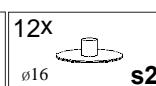
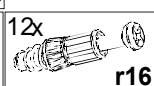
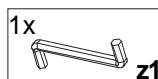
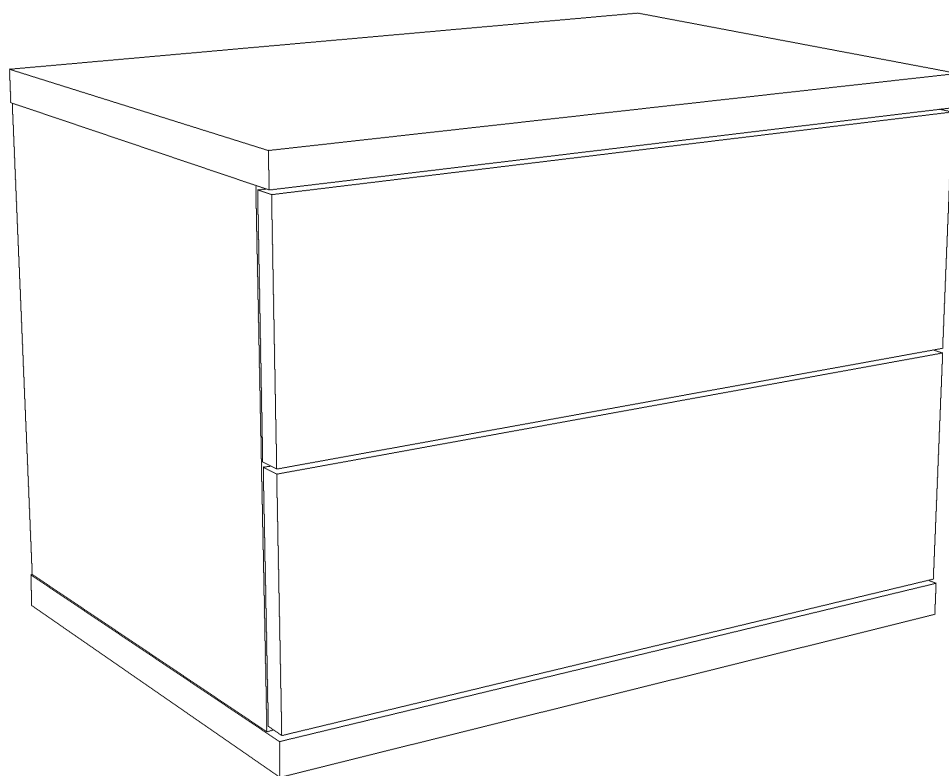
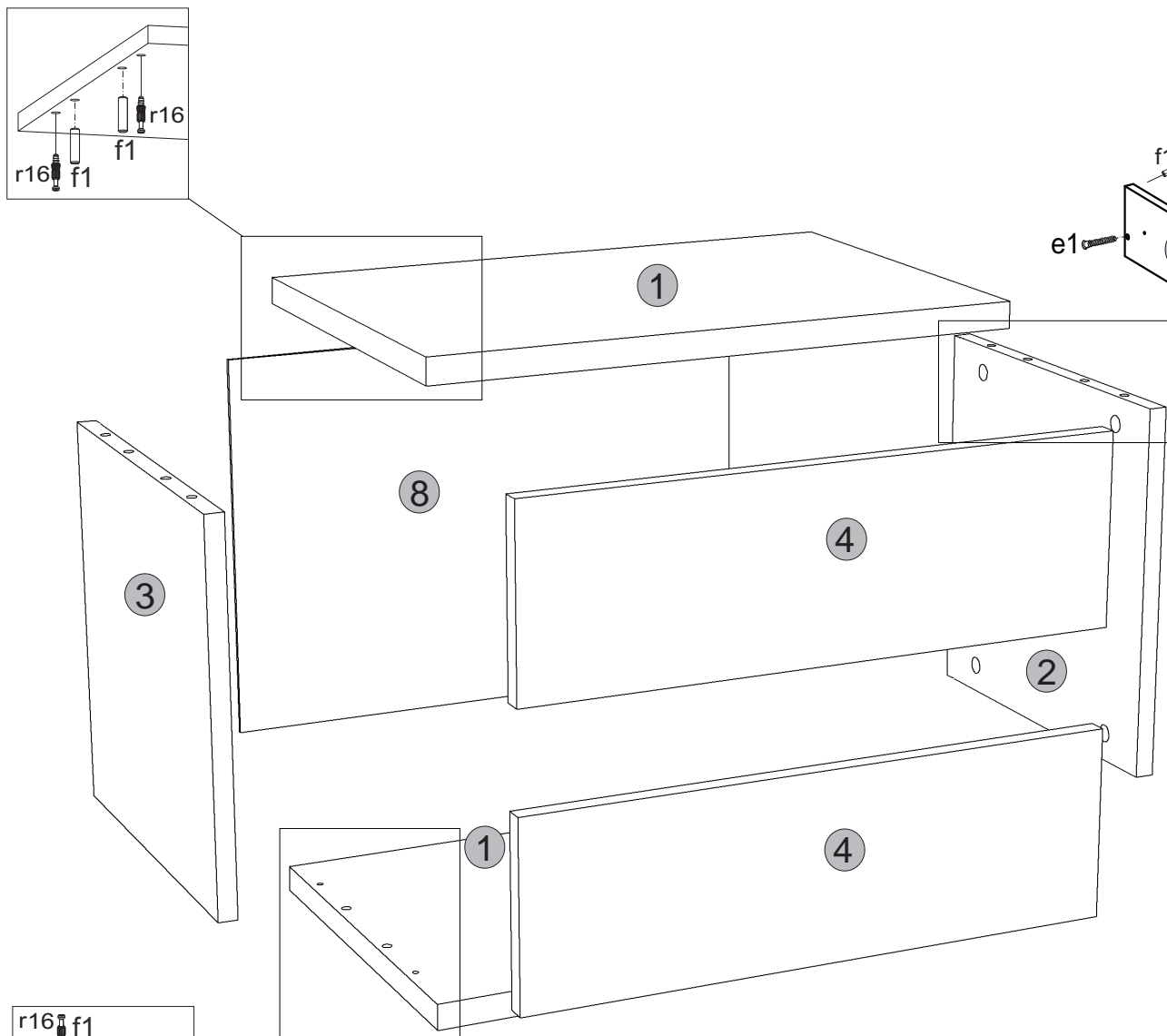
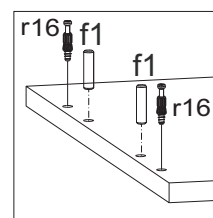
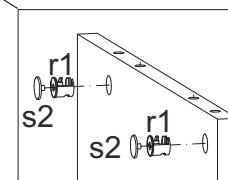
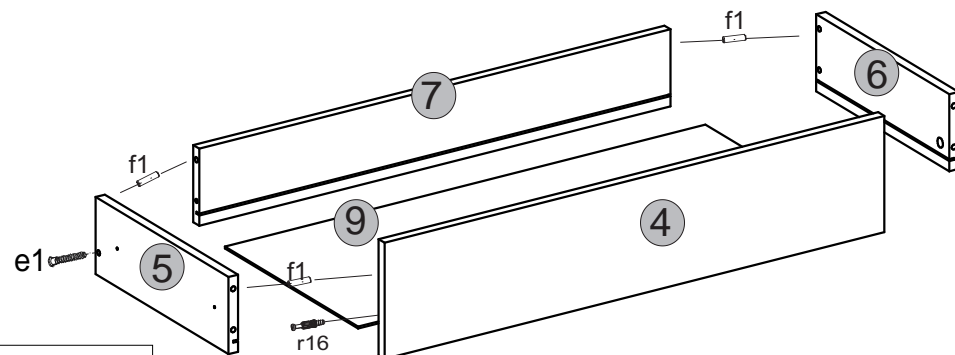
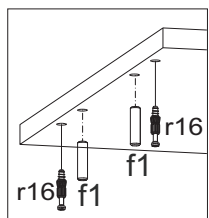

Nº					
1j-204	502	347	16	2	
2j-107	323	330	16	1	
3j-108	323	330	16	1	
4j-005	157	498	16	2	
5j-504	300	120	16	2	
6j-505	300	120	16	2	
7j-506	411	120	16	2	
8j-609	341	486	3	1	
9j-610	425	298	3	2	