

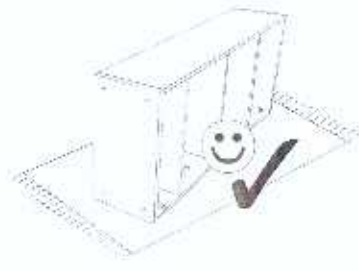

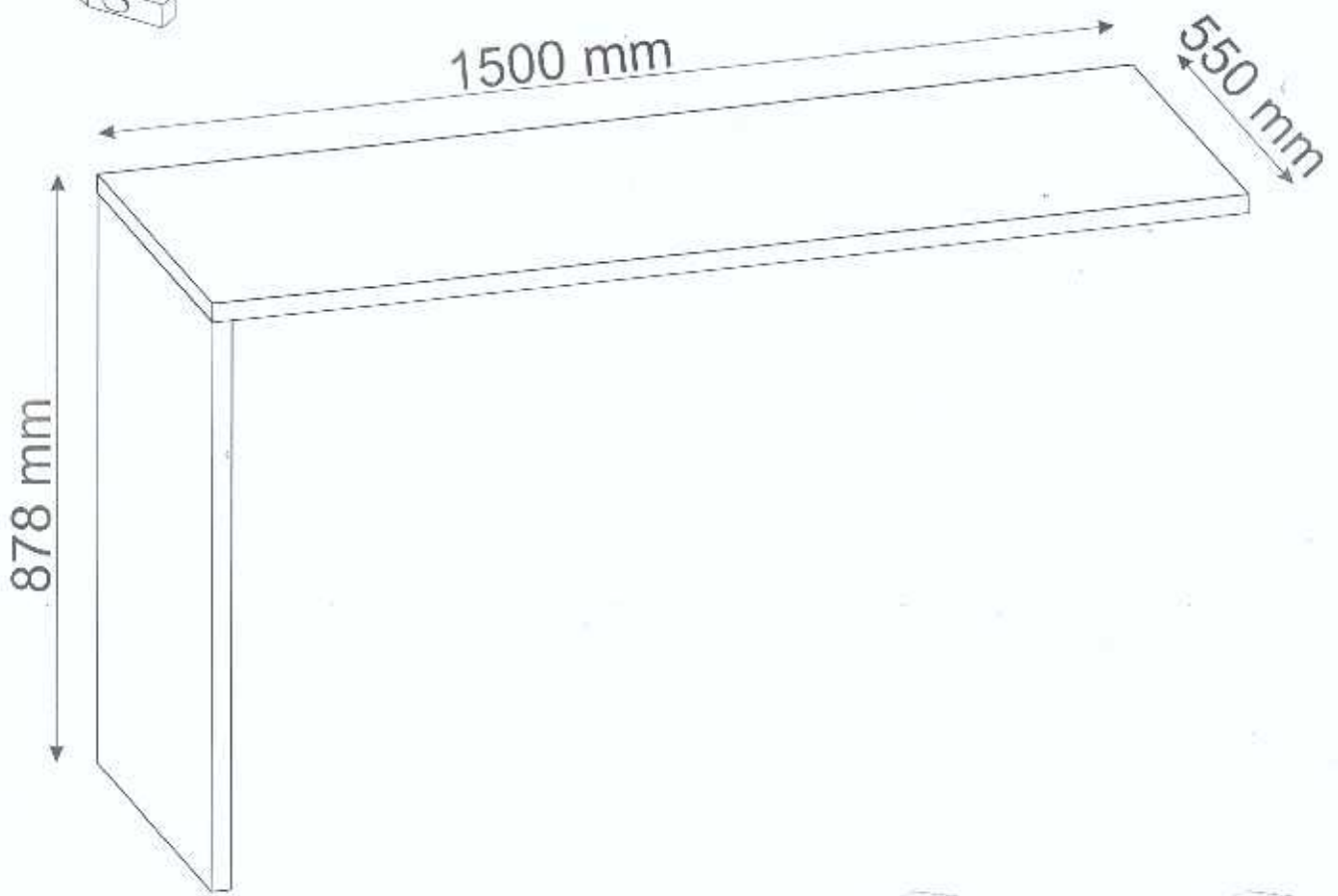

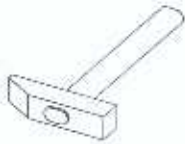
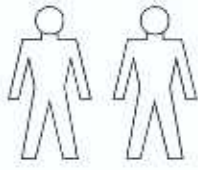

# CHARLOTTE

# SIDE TABLE



# CHARLOTTE SIDE TABLE

<b>A0</b> 8 x 32mm x5 	<b>C0</b> x10 	<b>C2</b> x10 
<b>C7</b> 16 mm x10 	<b>C17</b> M6 x2 	<b>T16</b> x2 

<b>1</b>	1500	550	28 x2	1/1
<b>2</b>	842	546	28 x1	1/1
<b>3</b>	140	140	16 x1	1/1
<b>4</b>	140	140	16 x1	1/1
				1/1

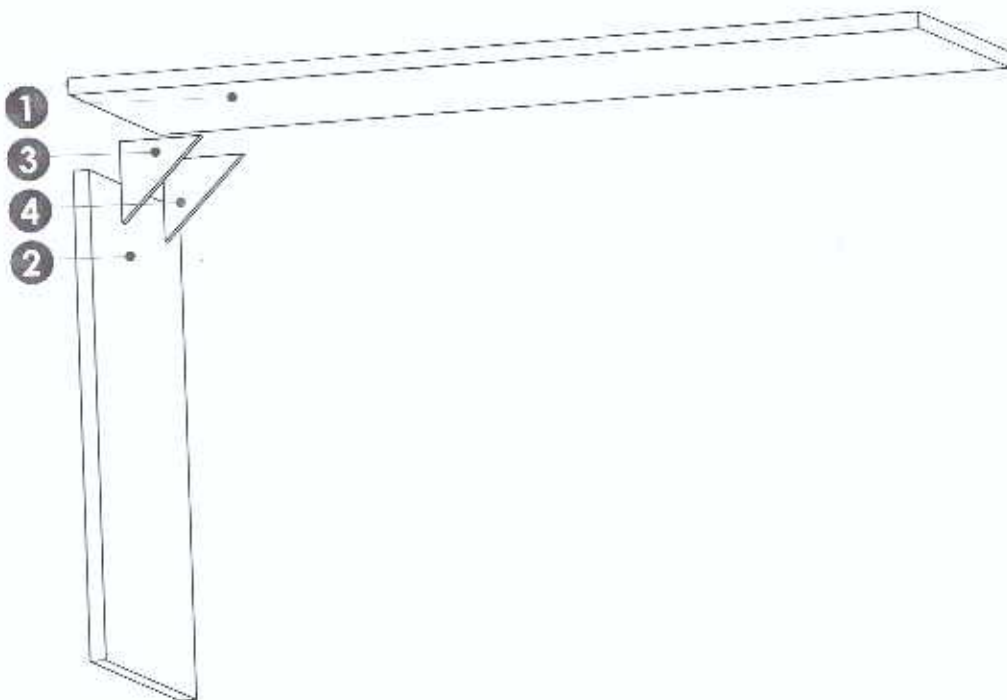

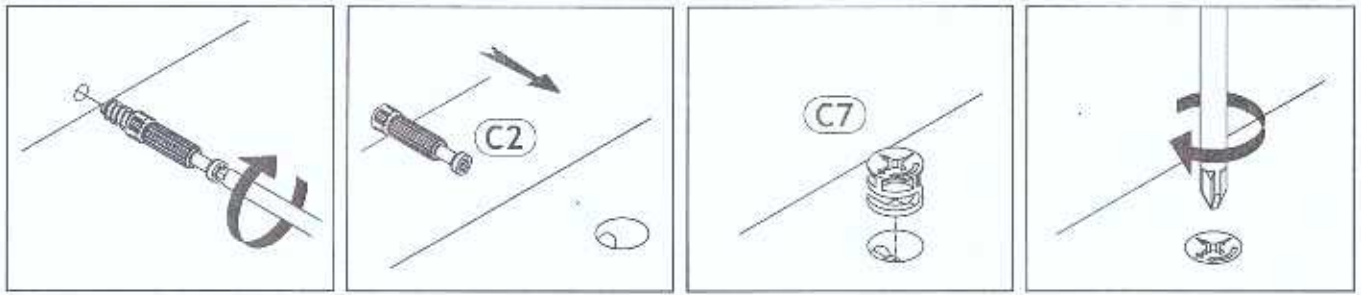

1 ▶

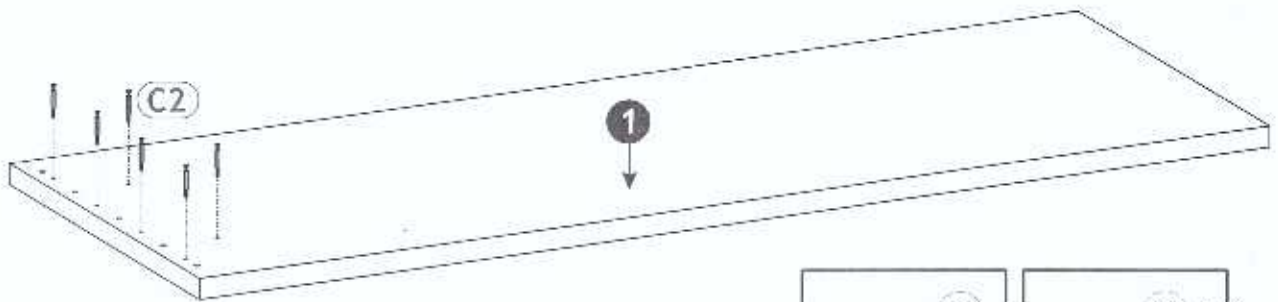

2 ▶

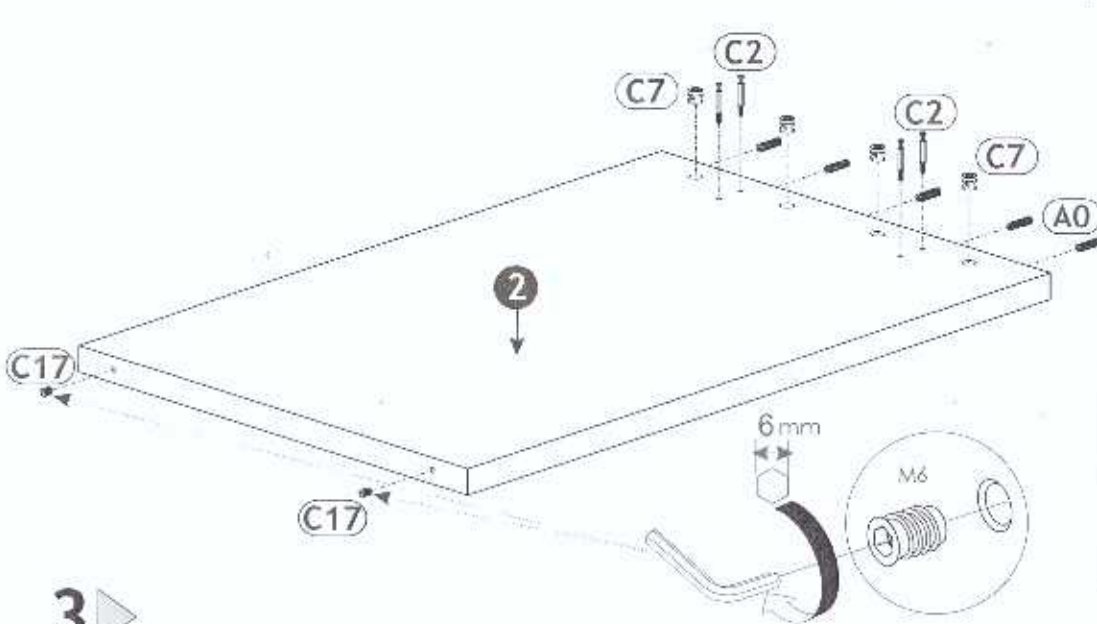

3 ▶

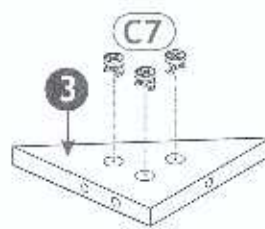
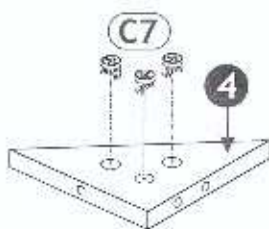

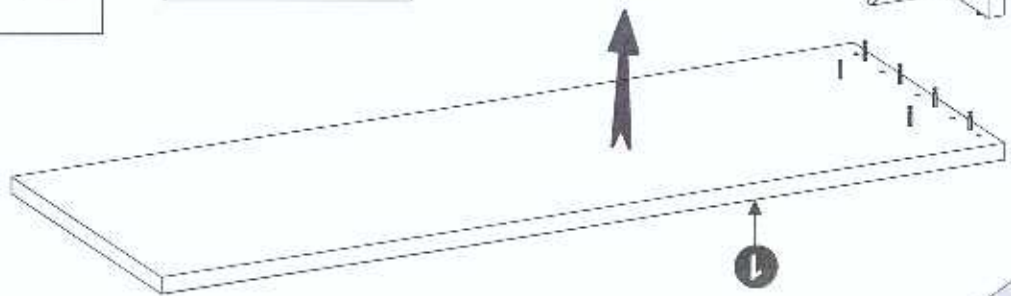
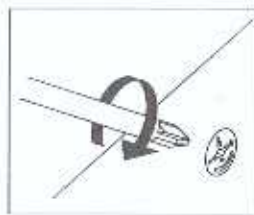
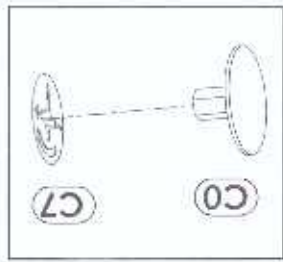
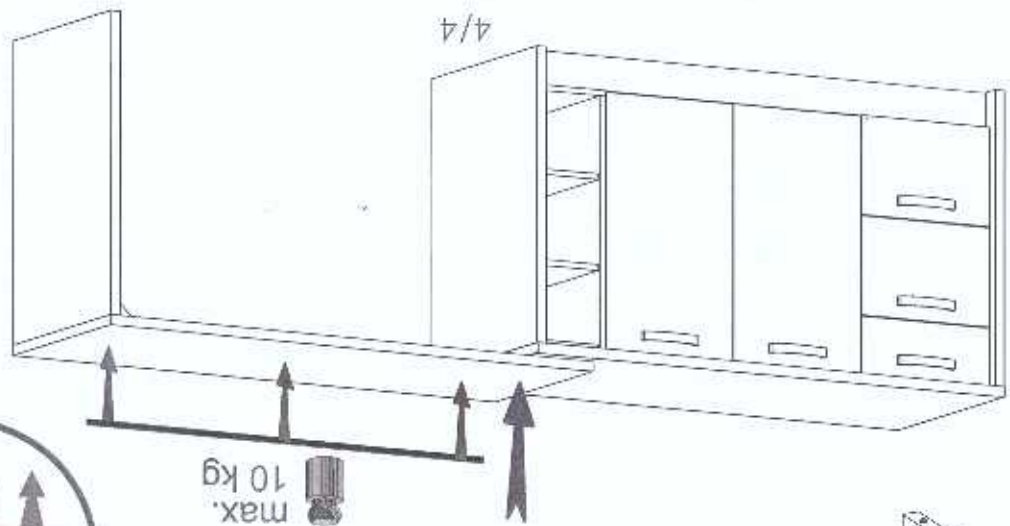

5

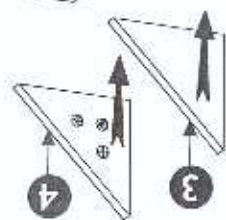
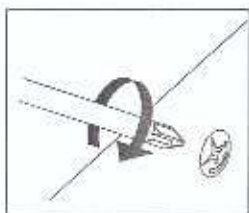
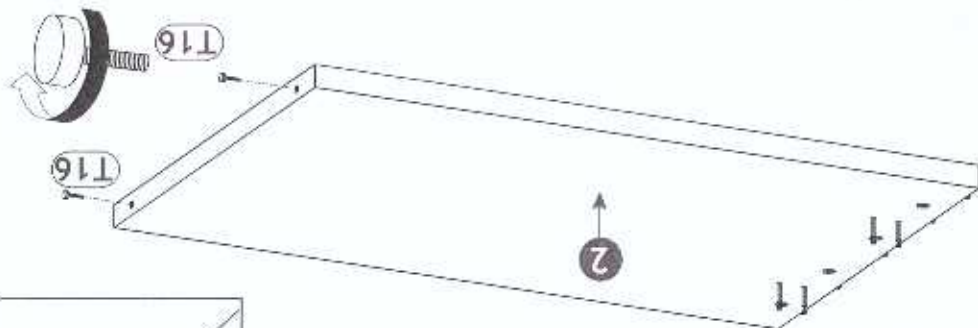

4