

A	1000x500	1/1
B	957x457	1/1
C	2x 384x120	1/1
D	2x 384x120	1/1
E	2x 384x104	1/1
F	2x 384x104	1/1

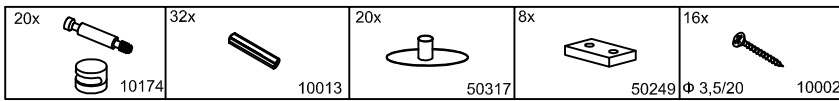

1

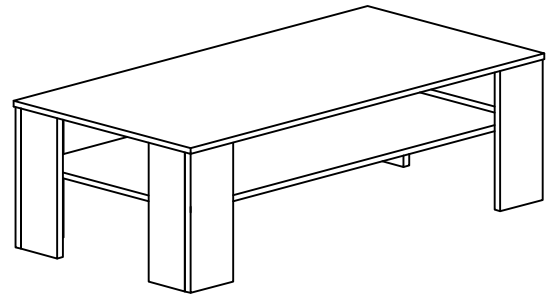
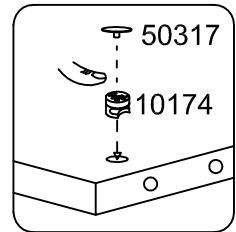
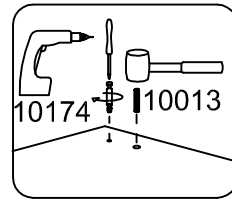
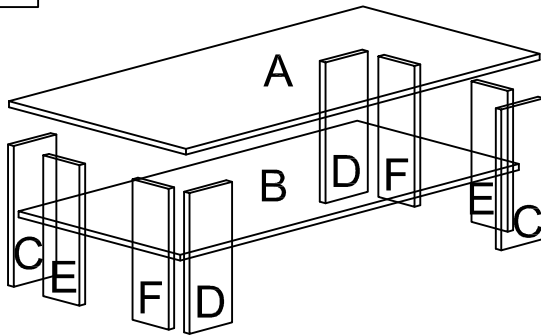

1.1

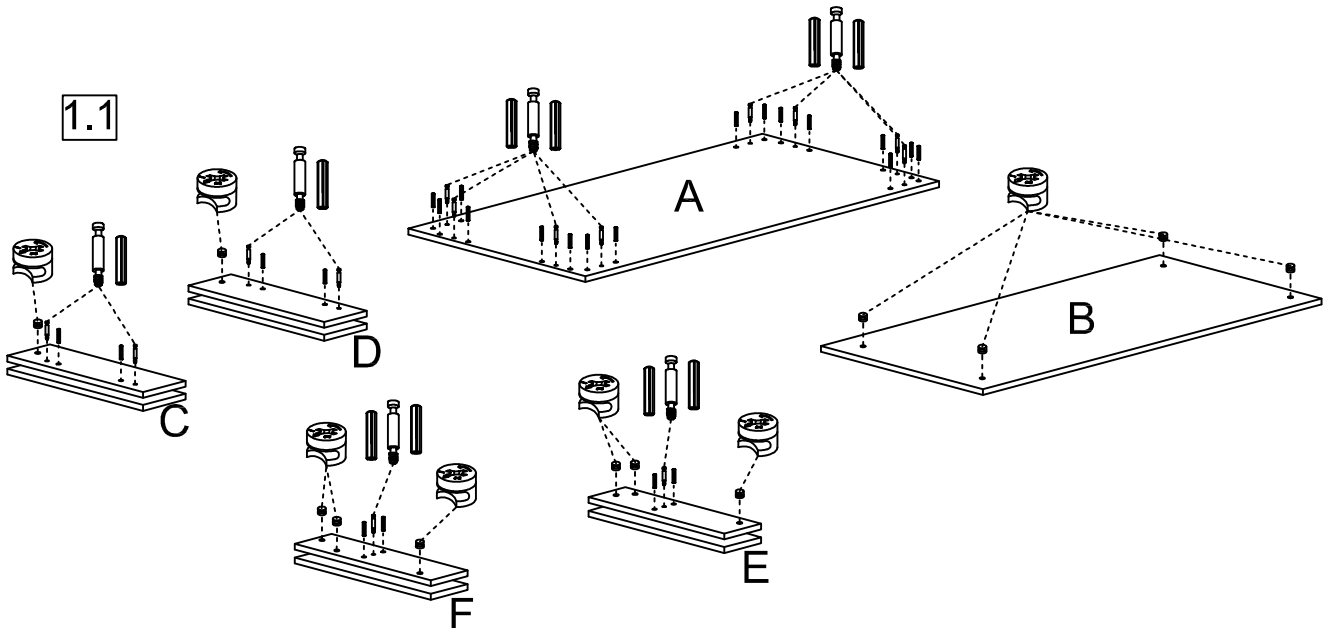

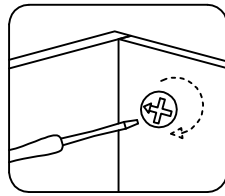
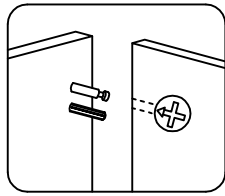

1.2

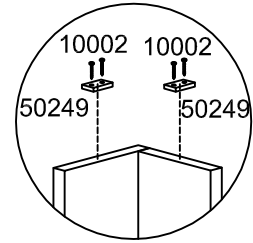
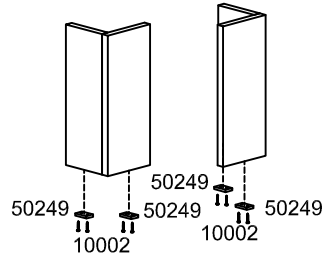
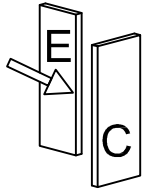
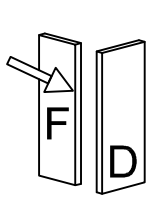
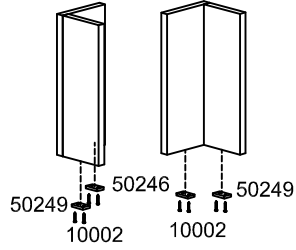
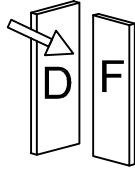
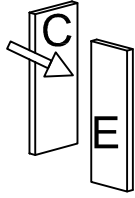

1.3

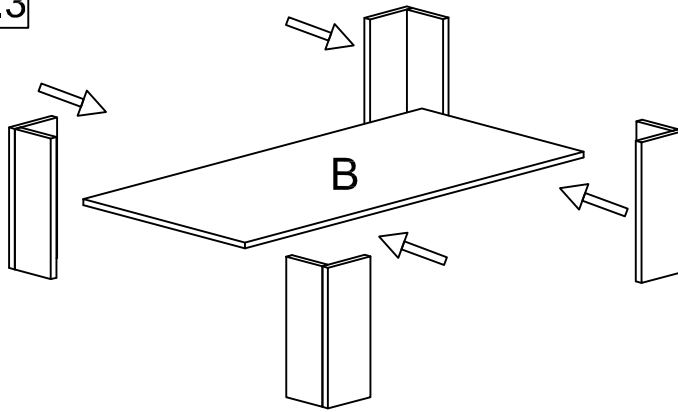

1.4

