

Wardrobe Diamont 140

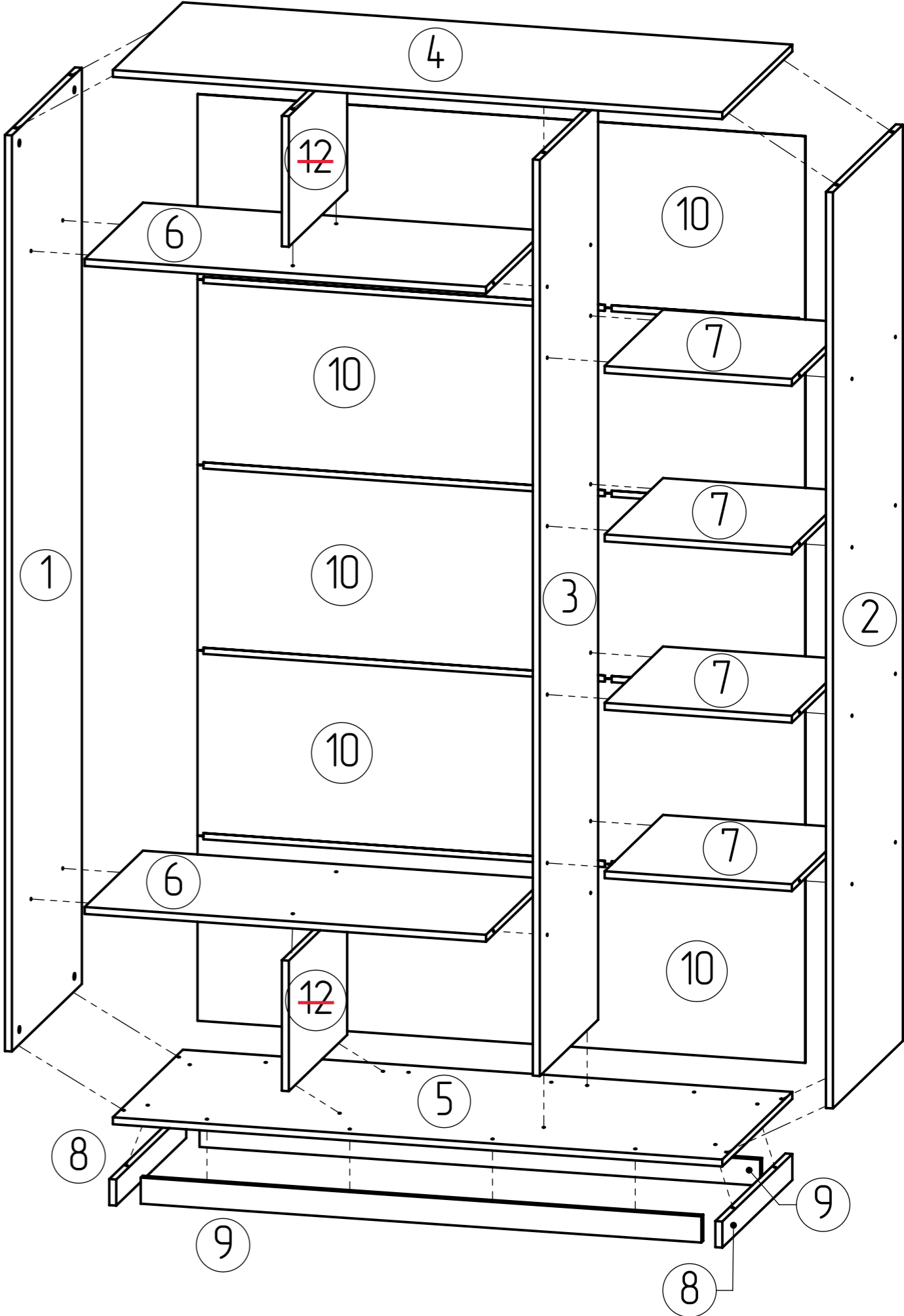
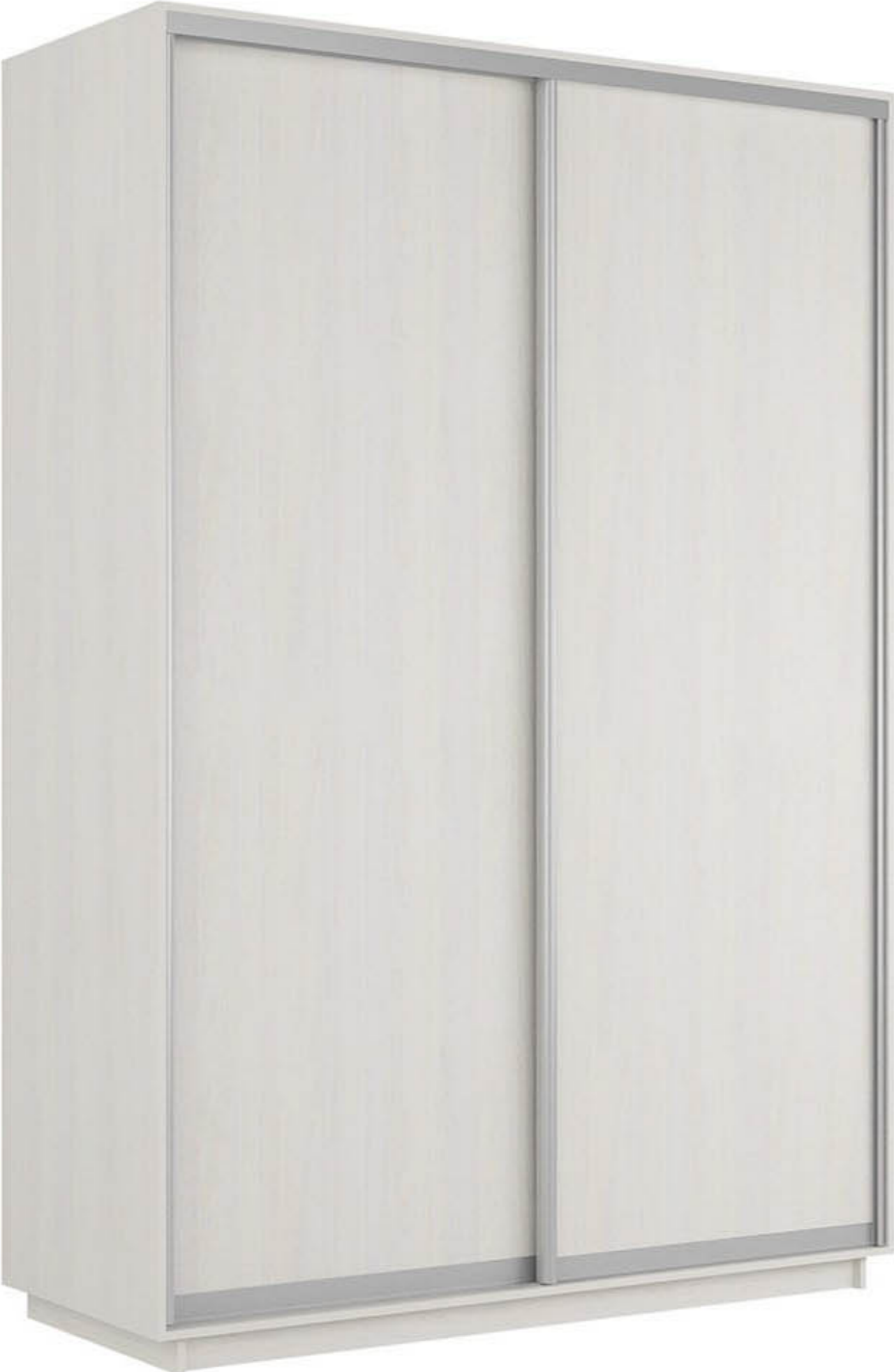

SDW 220x60x140-180

Nº	220x60x140	220x60x150	220x60x160	220x60x170	220x60x180	x
①	2105x600x16	2105x600x16	2105x600x16	2105x600x16	2105x600x16	1
②	2105x600x16	2105x600x16	2105x600x16	2105x600x16	2105x600x16	1
③	2105x500x16	2105x500x16	2105x500x16	2105x500x16	2105x500x16	1
④	1400x600x16	1500x600x16	1600x600x16	1700x600x16	1800x600x16	1
⑤	1400x600x16	1500x600x16	1600x600x16	1700x600x16	1800x600x16	1
⑥	922x500x16	1022x500x16	1122x500x16	1052x500x16	1152x500x16	2
⑦	430x500x16	430x500x16	430x500x16	600x500x16	600x500x16	4
⑧	600x60x16	600x60x16	600x60x16	600x60x16	600x60x16	2
⑨	1288x60x16	1388x60x16	1488x60x16	1588x60x16	1688x60x16	2
⑩	1396x531x2.5	1496x531x2.5	1596x531x2.5	1696x531x2.5	1796x531x2.5	4
⑪	2164x697	2164x747	2164x797	2164x847	2164x897	2
⑫	300x500x16	300x500x16	300x500x16	300x500x16	300x500x16	2
⑬	L=1366	L=1466	L=1566	L=1666	L=1766	3
⑭	L=1366	L=1466	L=1566	L=1666	L=1766	3

<p>(A) 6.3*50</p>  <p>x45</p>	<p>(A1)</p>  <p>x45</p>	<p>(B) 4*16</p>  <p>x24</p>	<p>(C)</p>  <p>x12</p>
<p>(D)</p>  <p>70</p>	<p>(E)</p>  <p>x16</p>	<p>(E1)</p>  <p>x16</p>	<p>(F)</p>  <p>x9.40</p>
<p>(G)</p>  <p>x2</p>	<p>(G1)</p>  <p>x1</p>	<p>(H)</p>  <p>x2</p>	<p>(I)</p>  <p>x8</p>
<p>(J)</p>  <p>x8</p>	<p>(K) 3.5*16</p>  <p>x6</p>	<p>(L)</p>  <p>x1</p>	

1

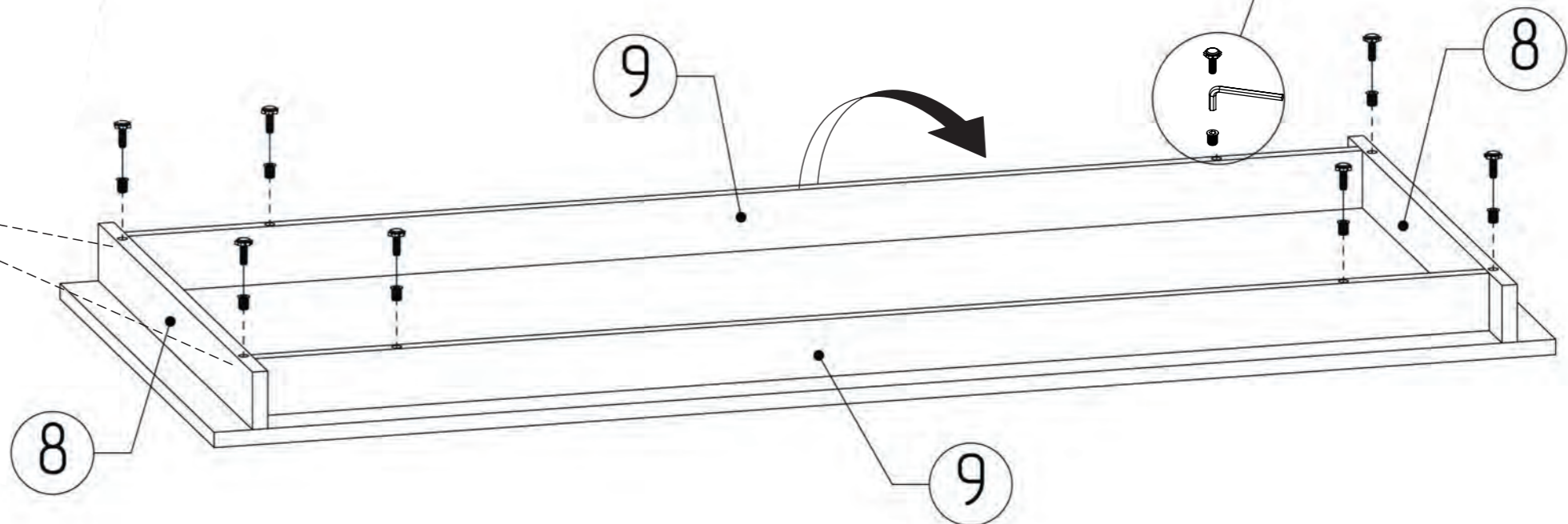
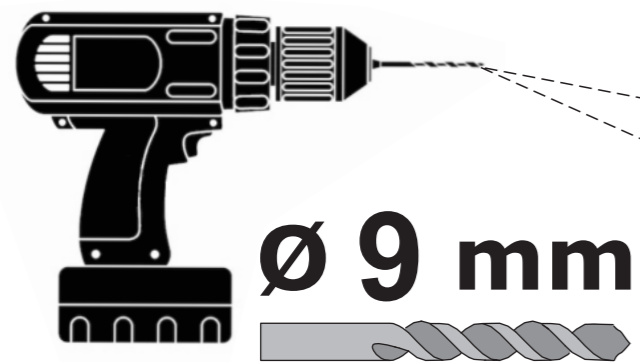
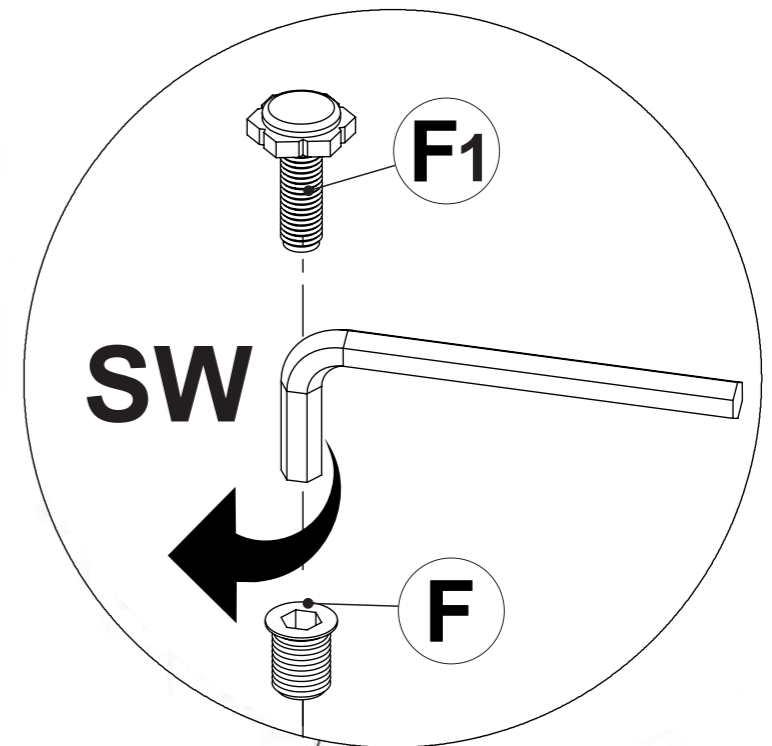
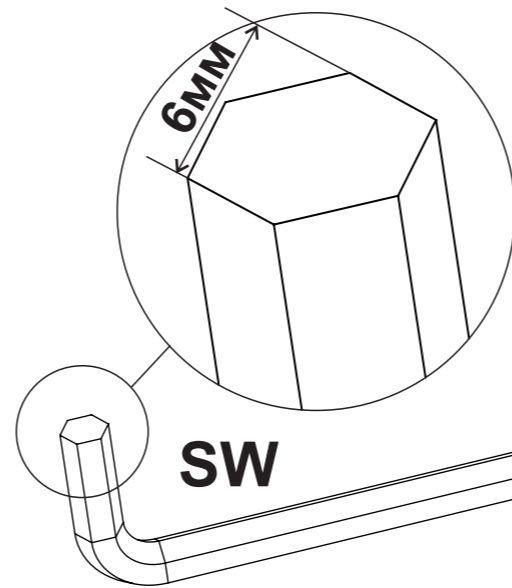
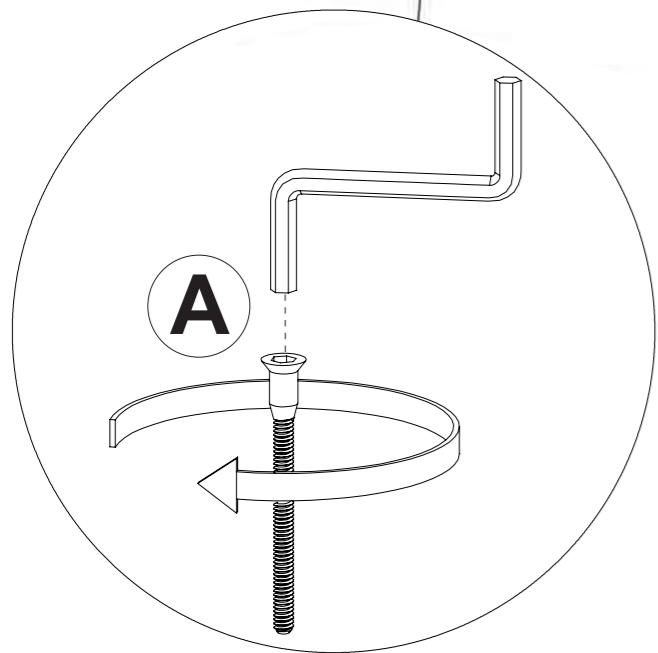
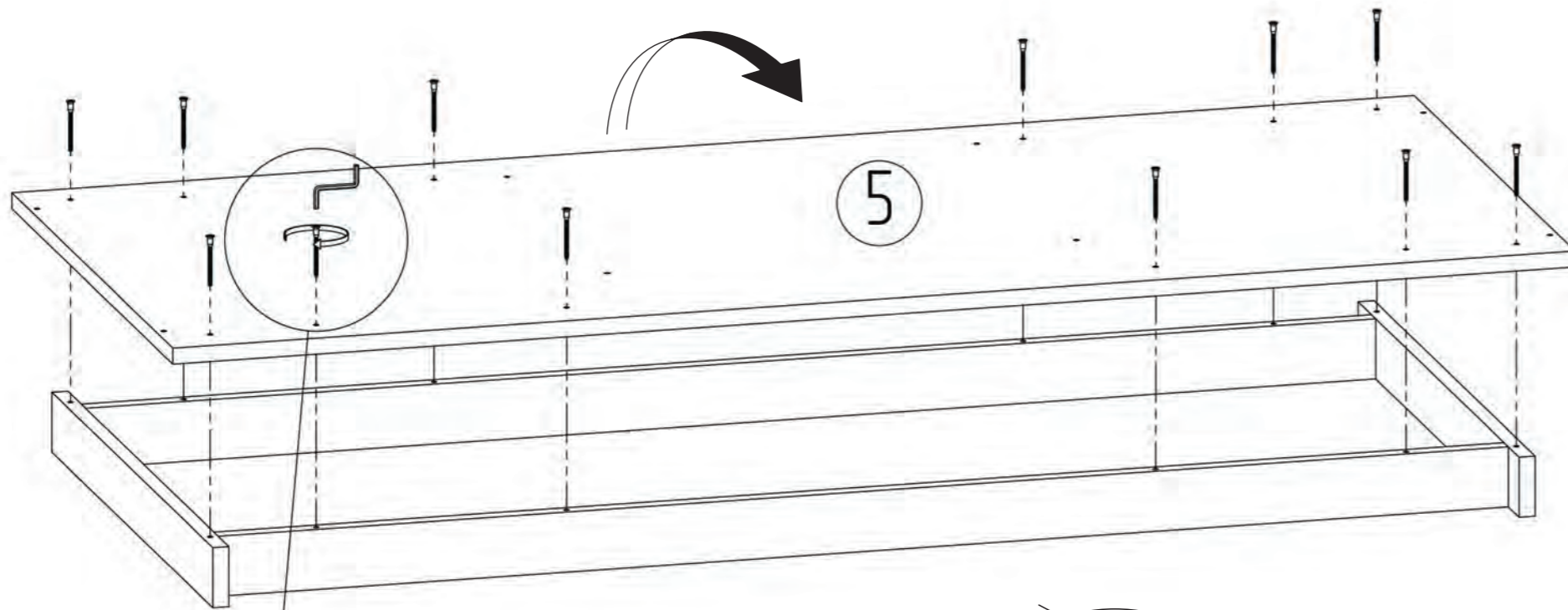

2

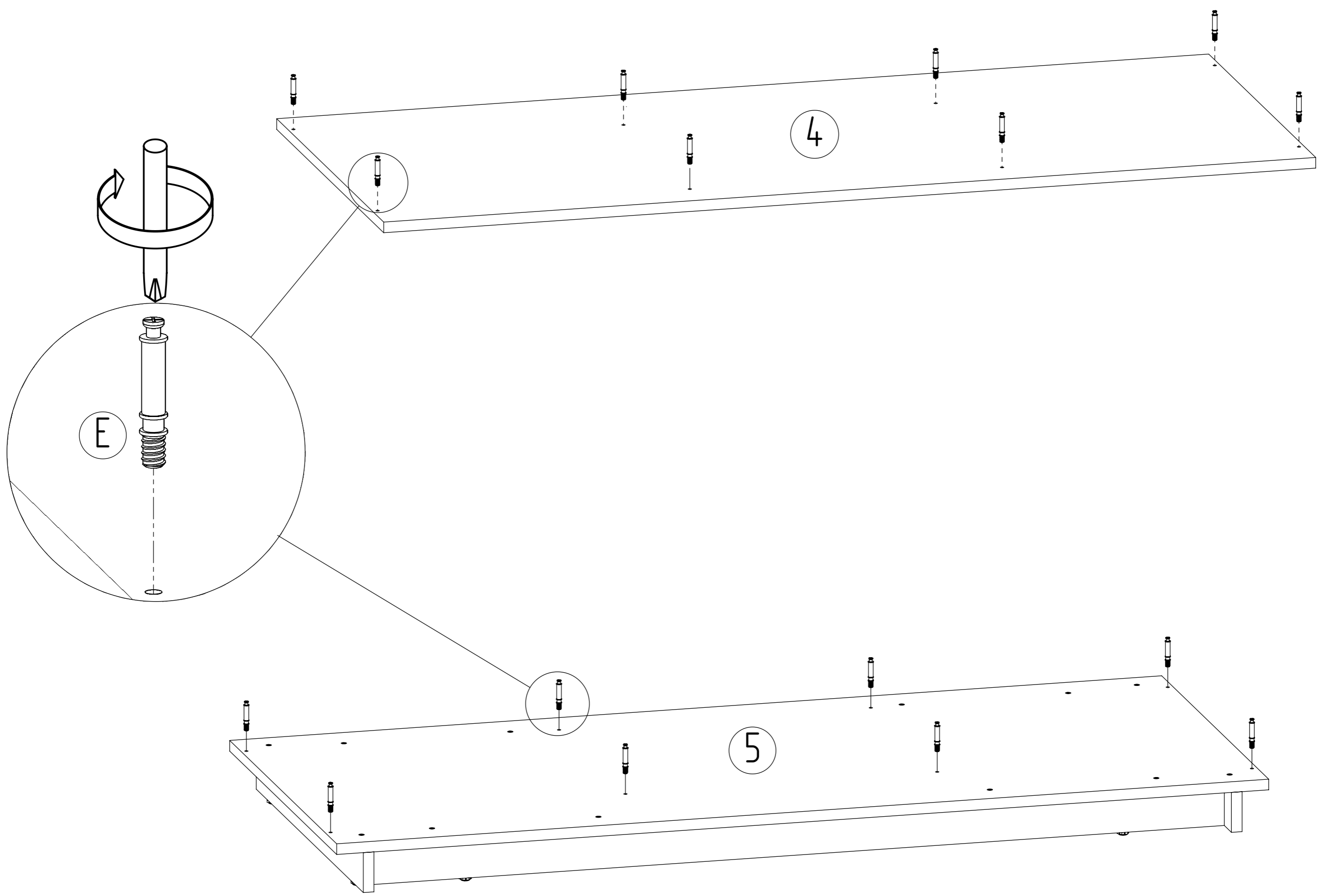

3

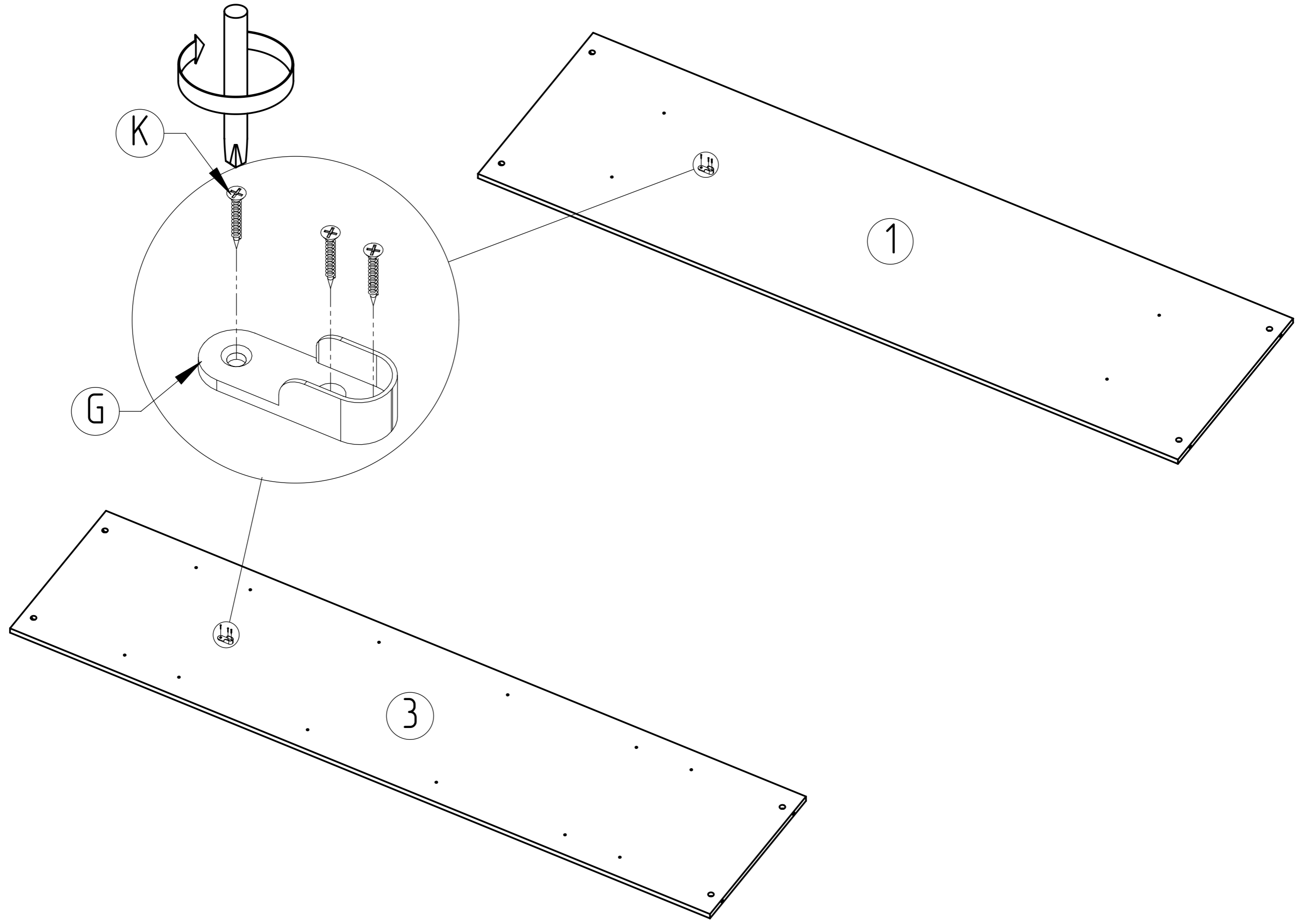

4

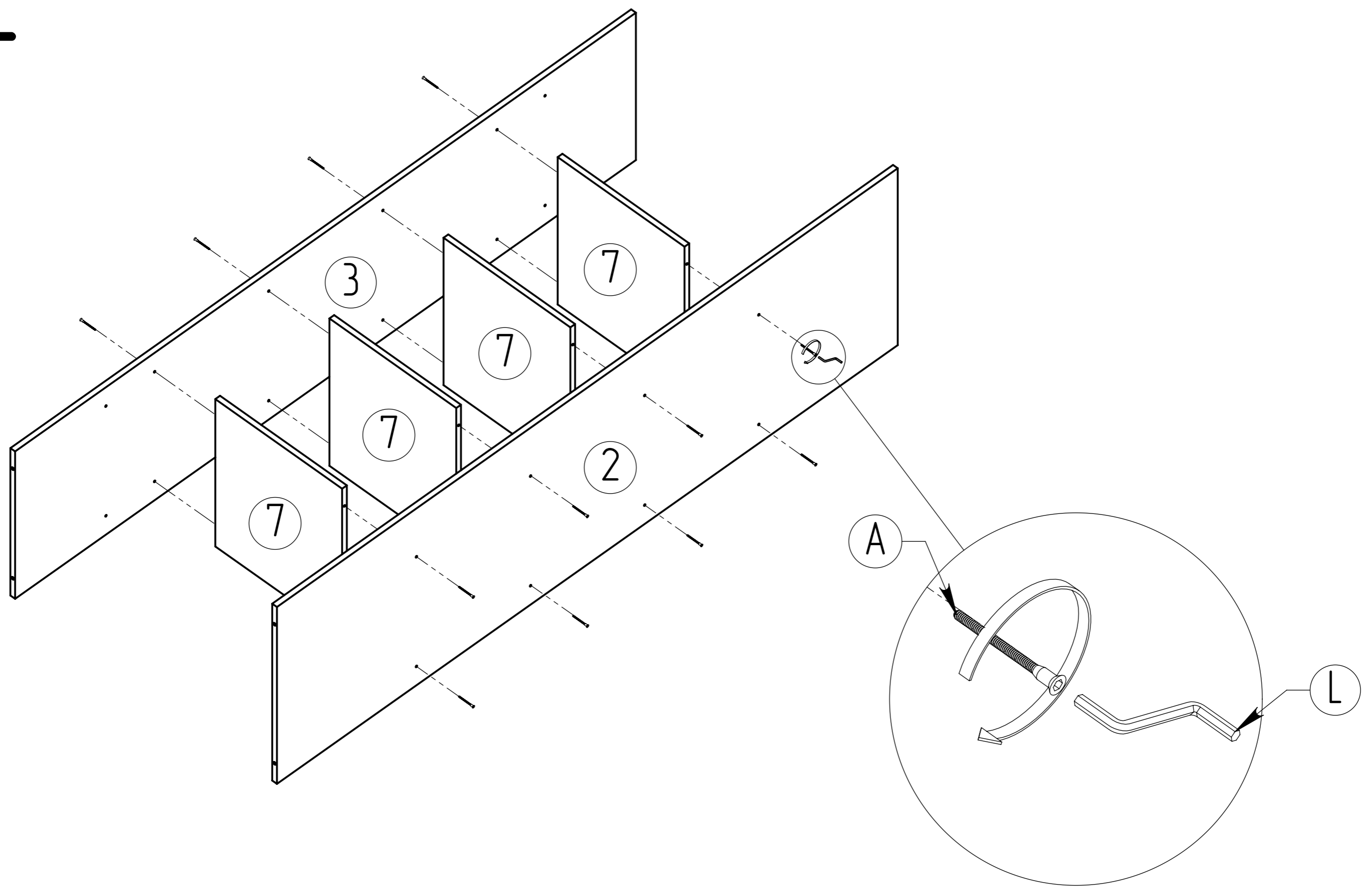

5

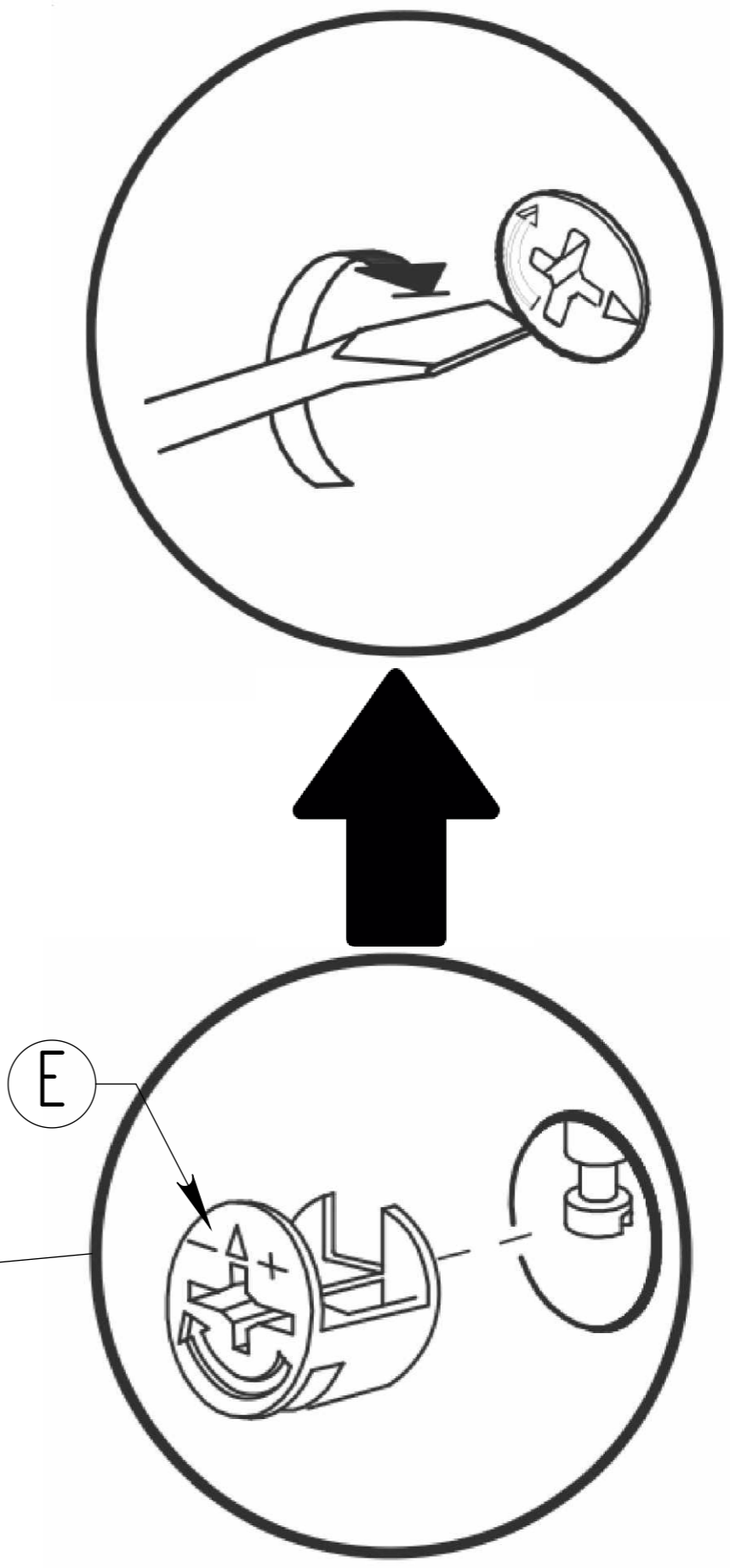
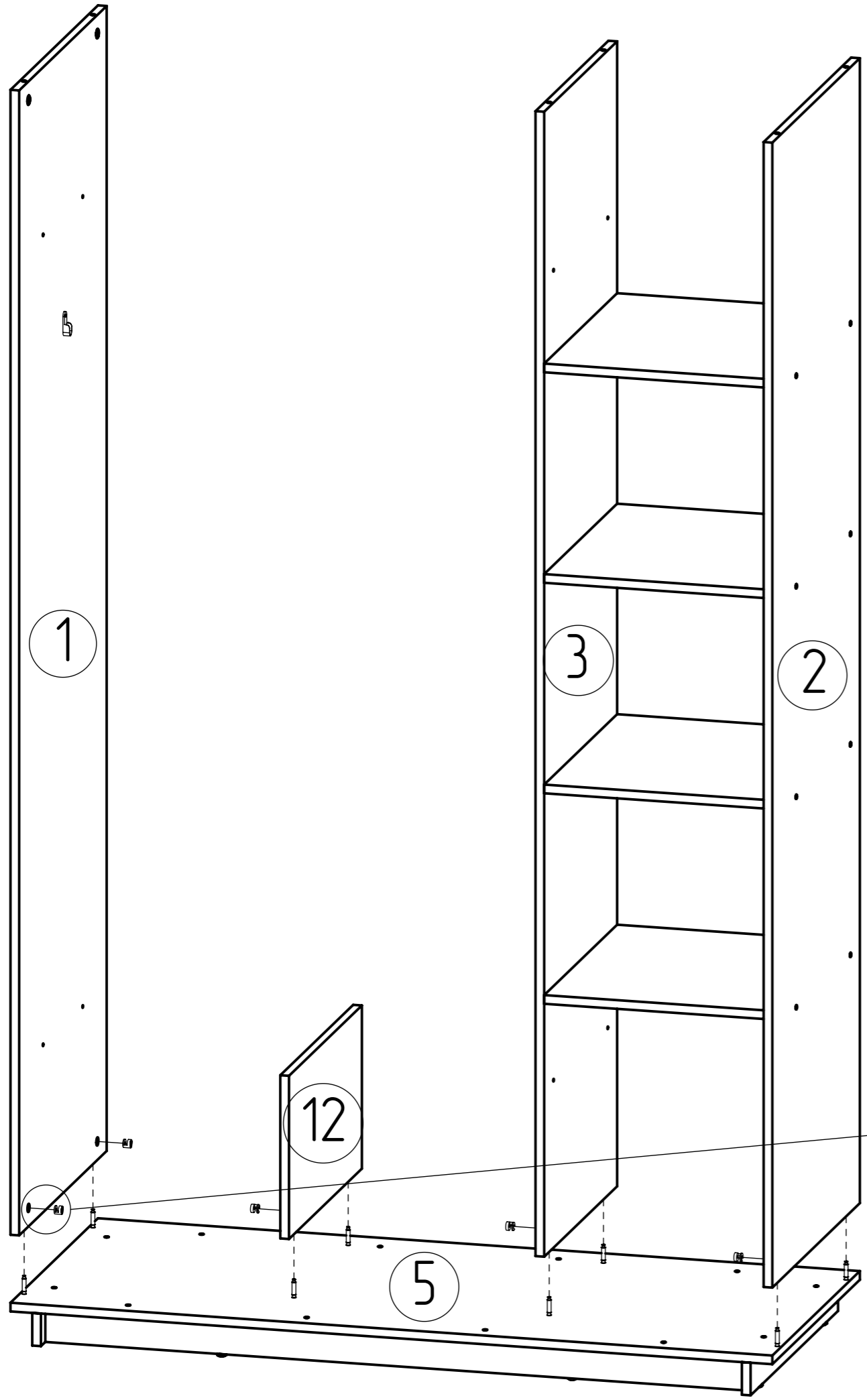

6

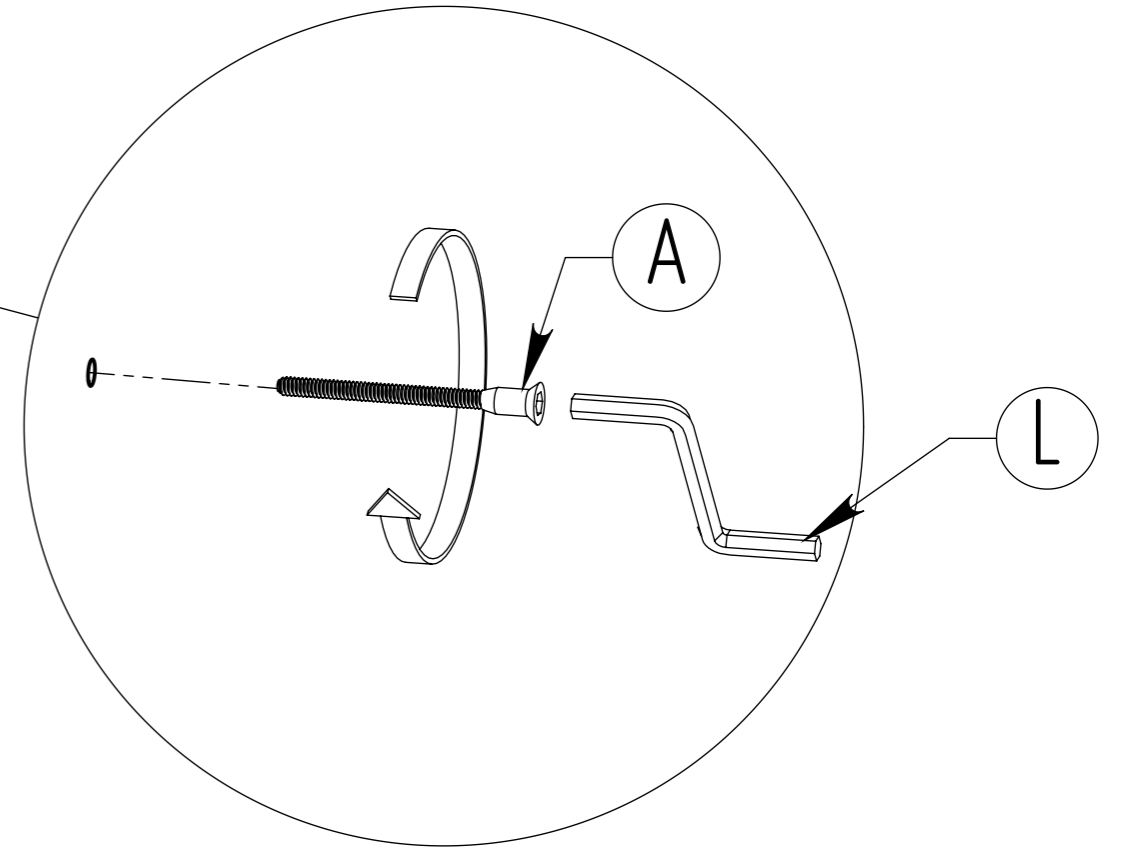
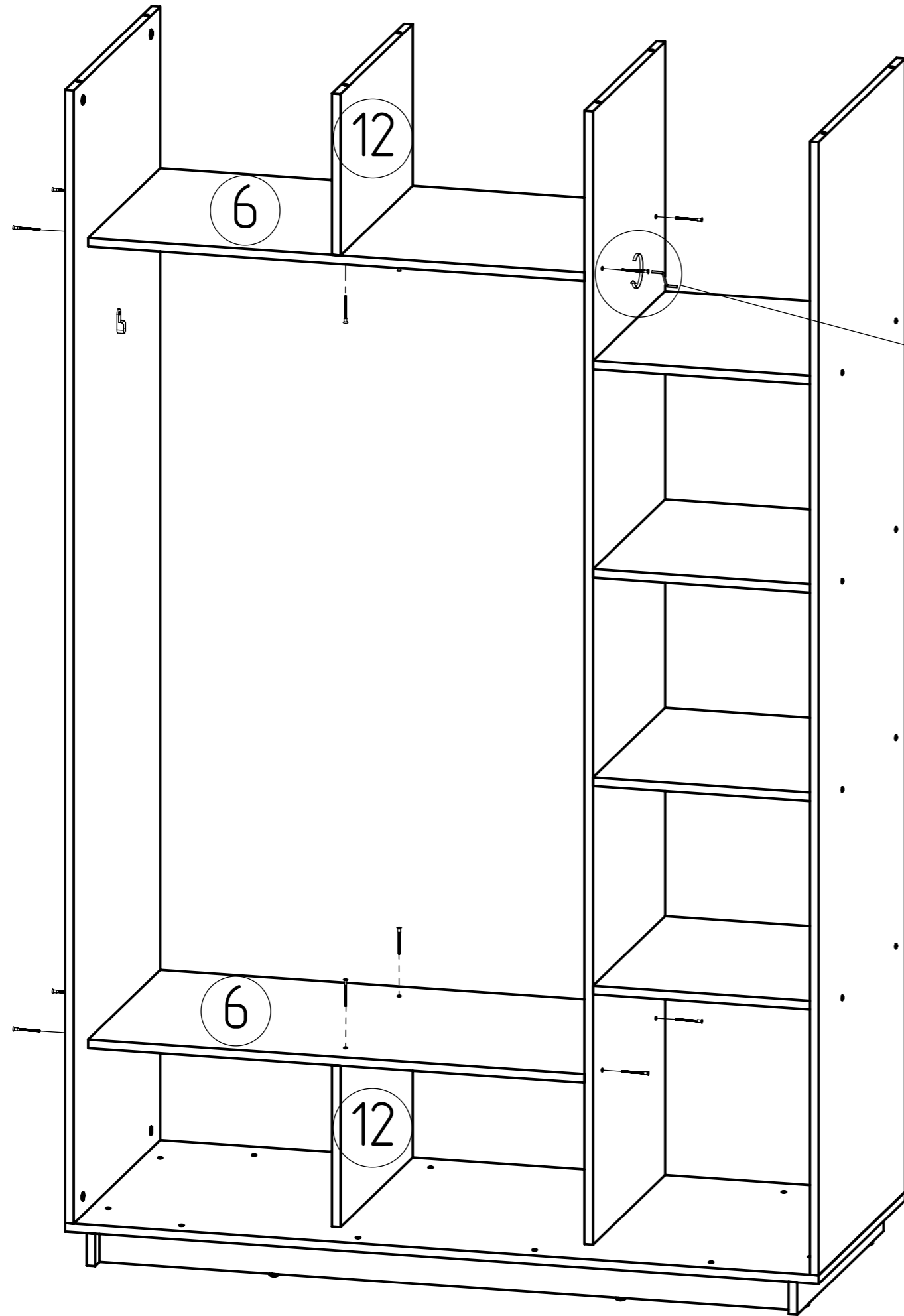

7

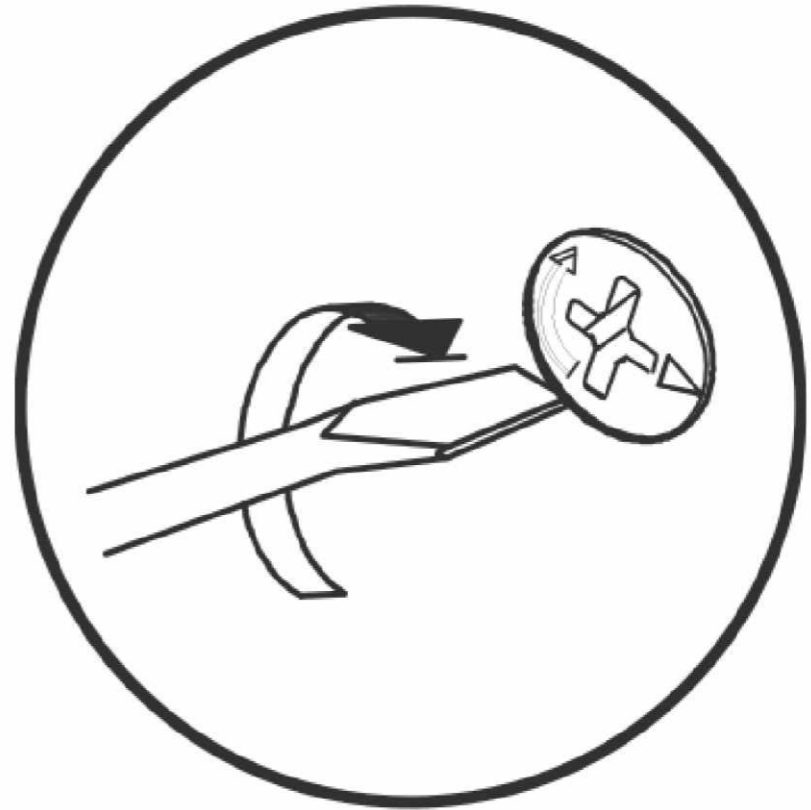
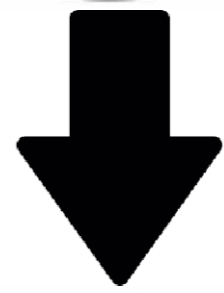
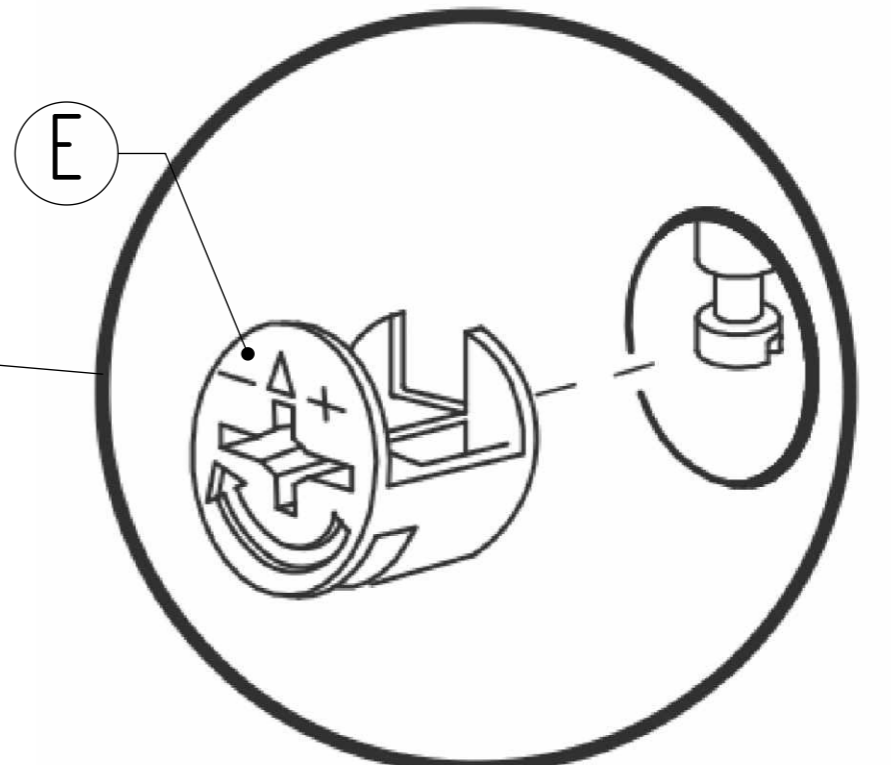
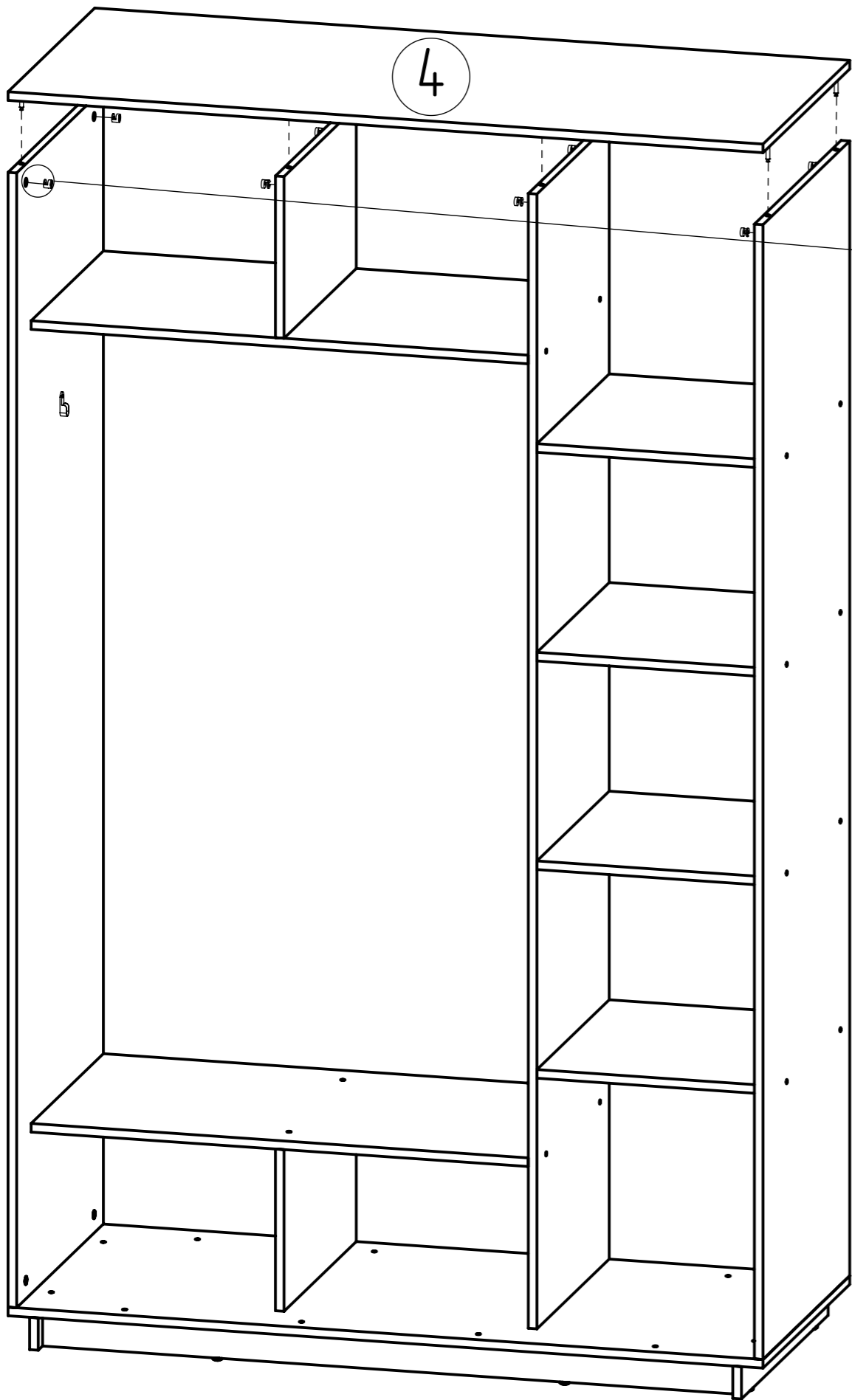

8

$$a = b$$

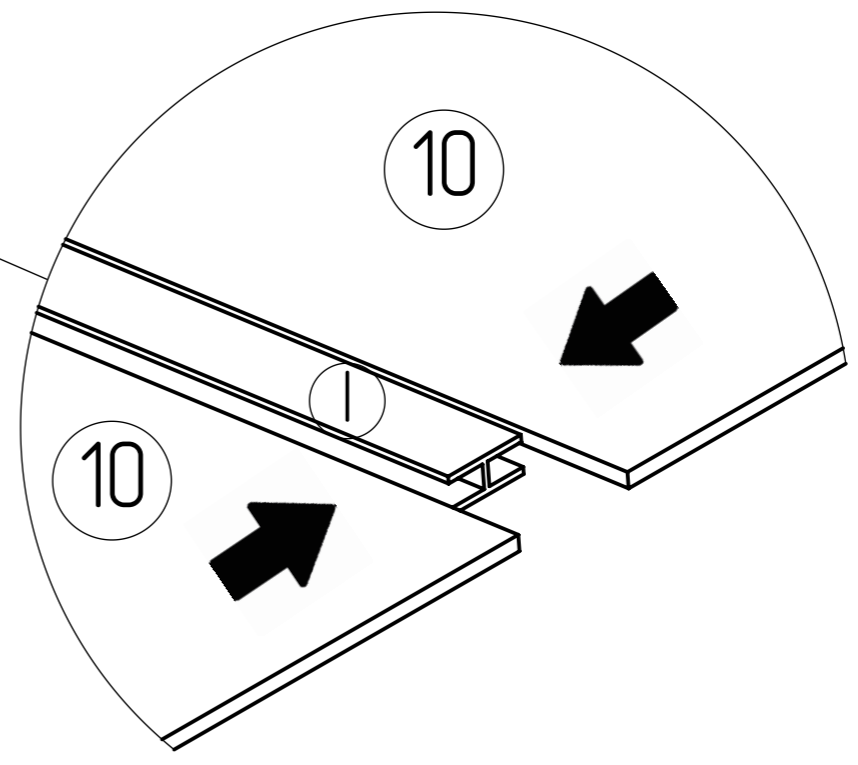
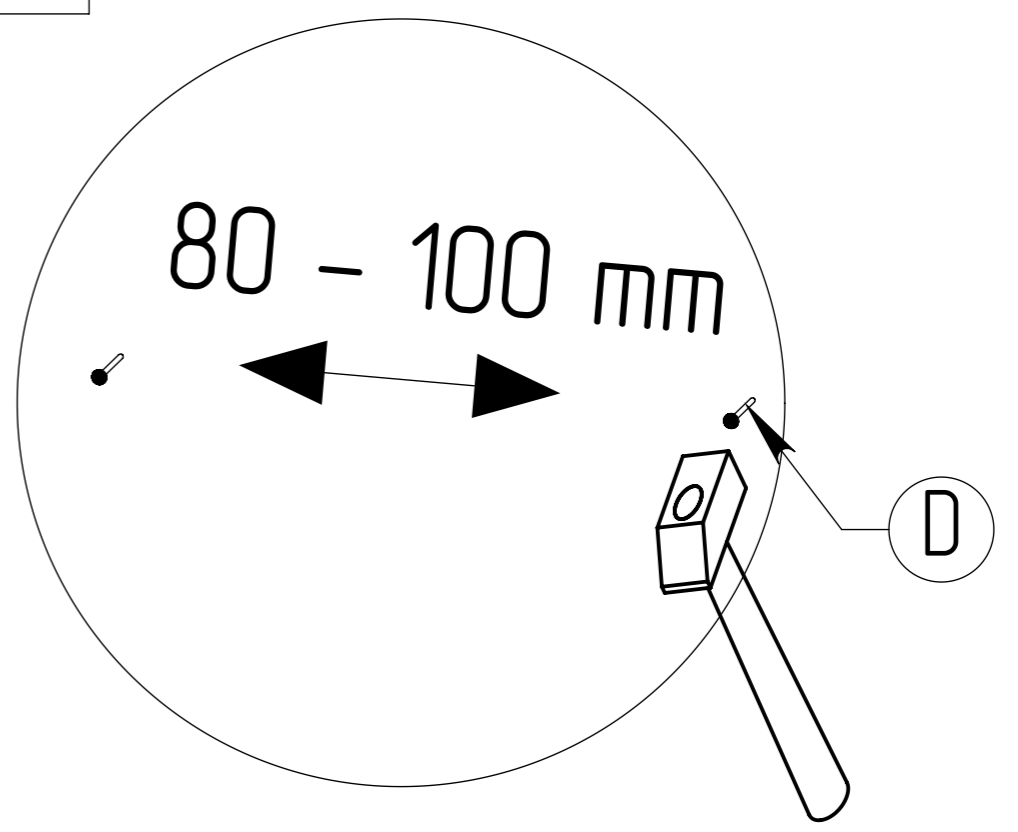
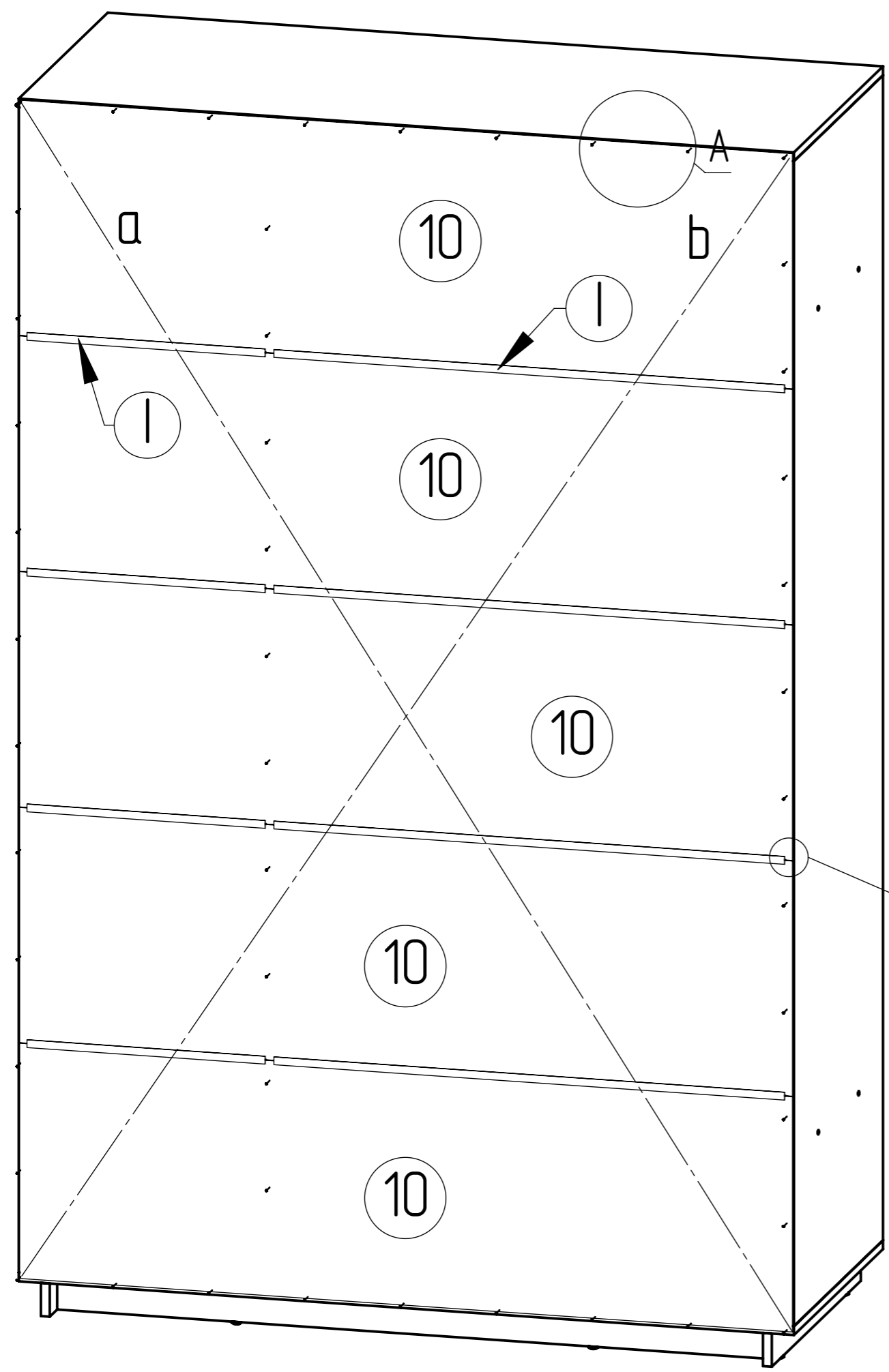

9

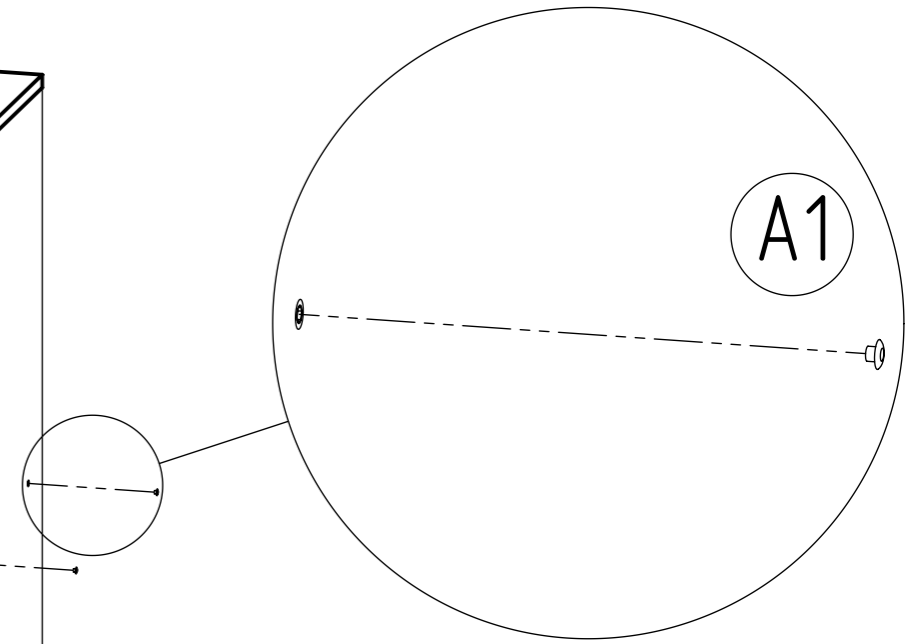
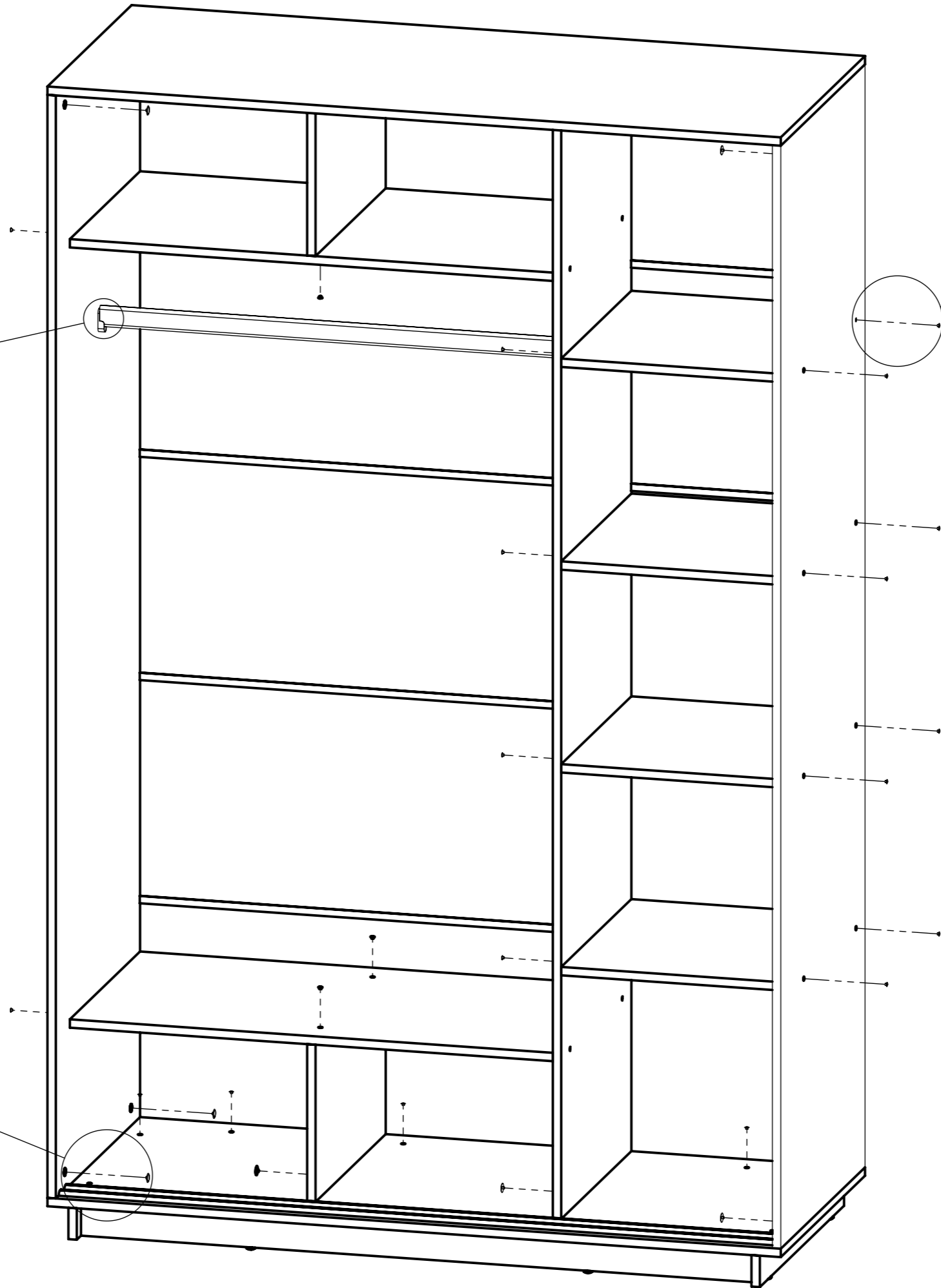
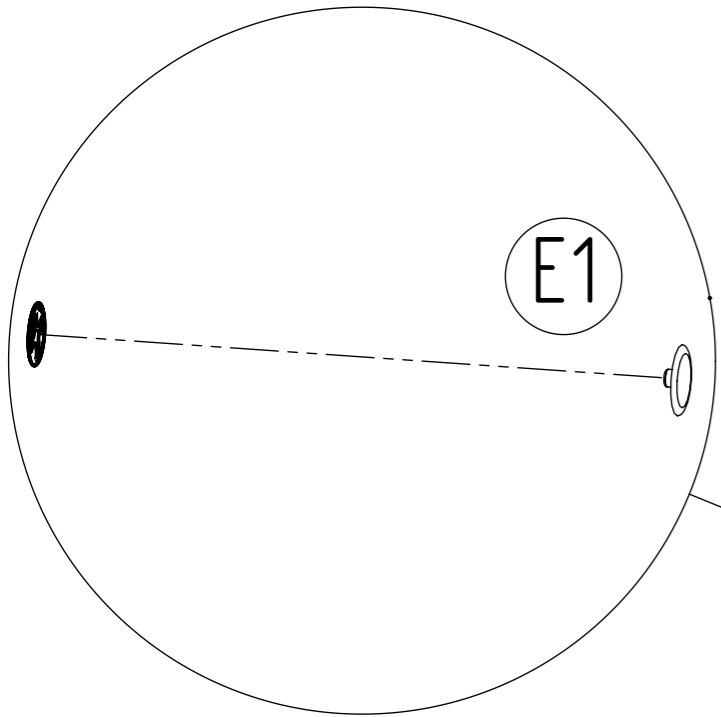
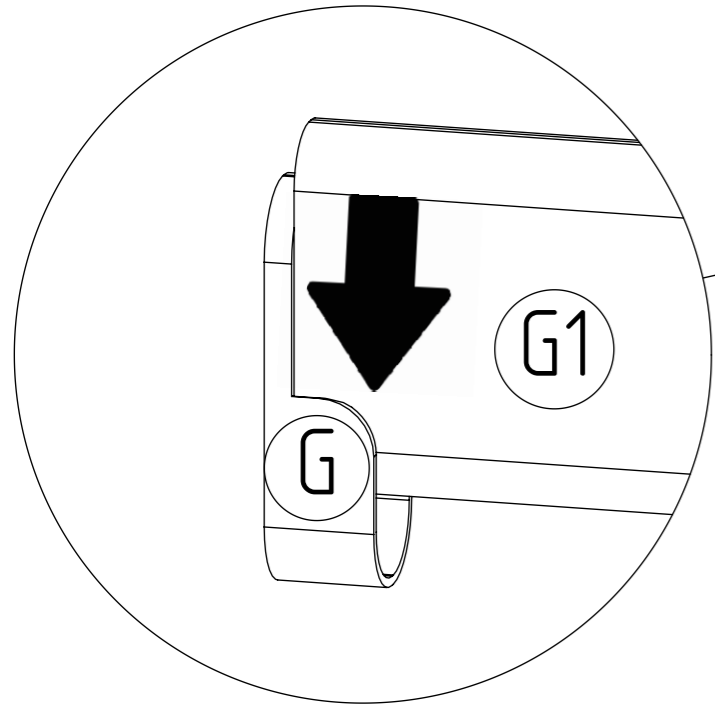

10

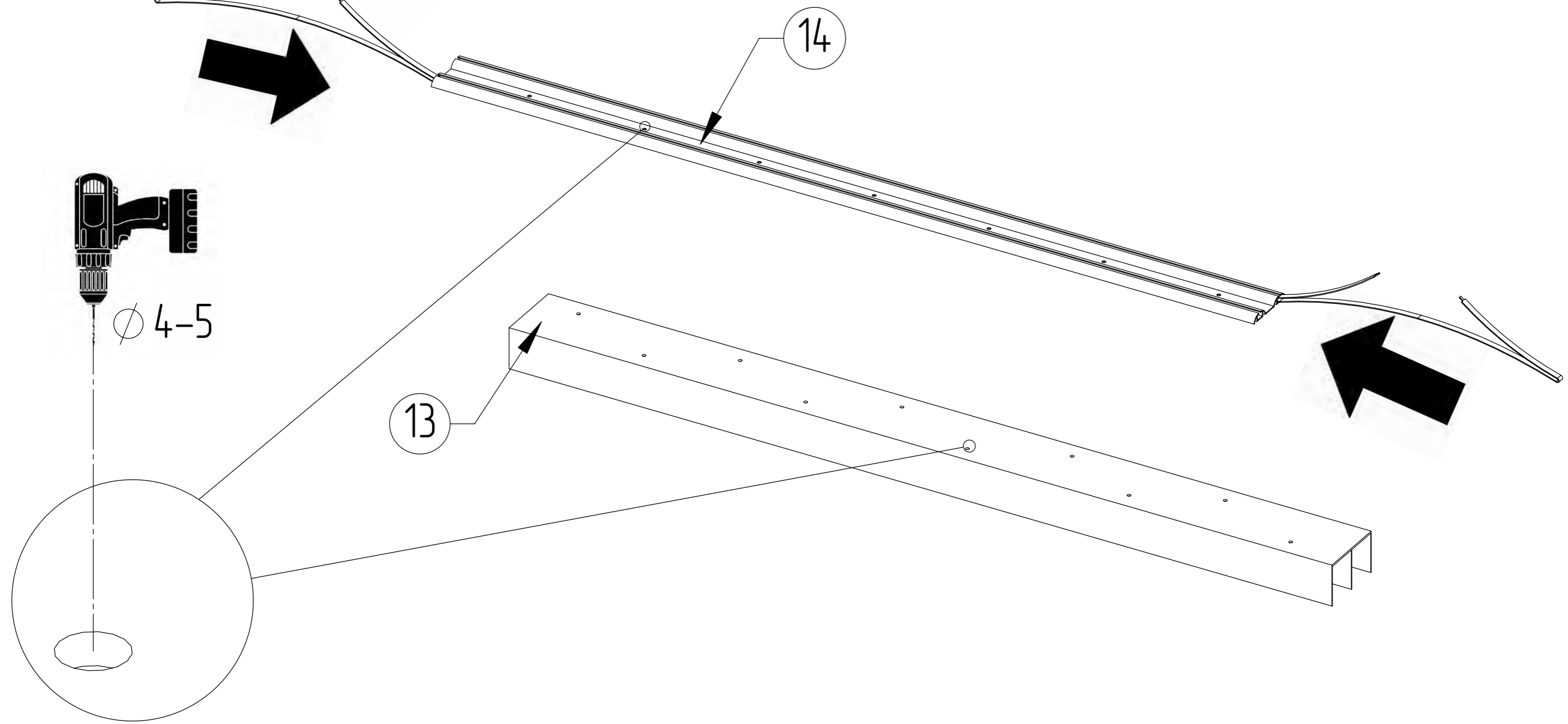
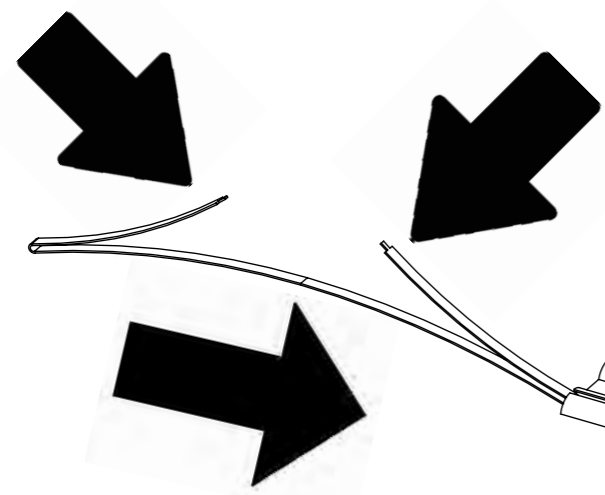

∅ 4-5

13

14

11

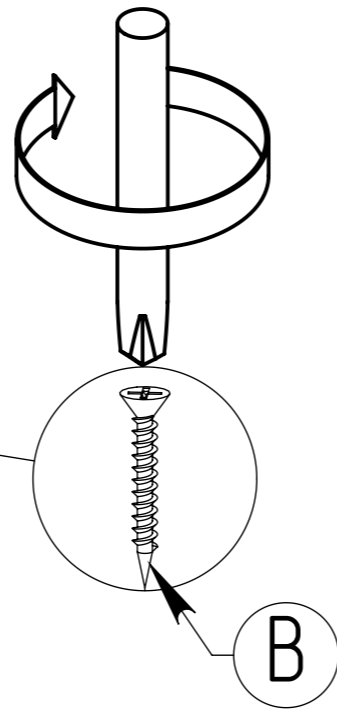
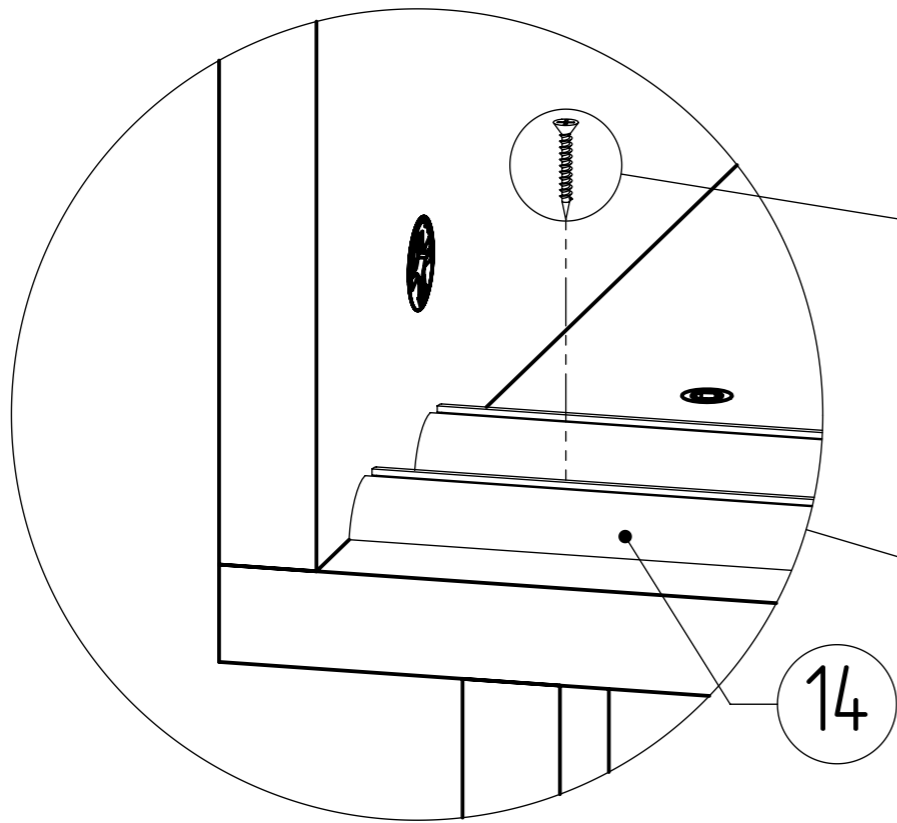
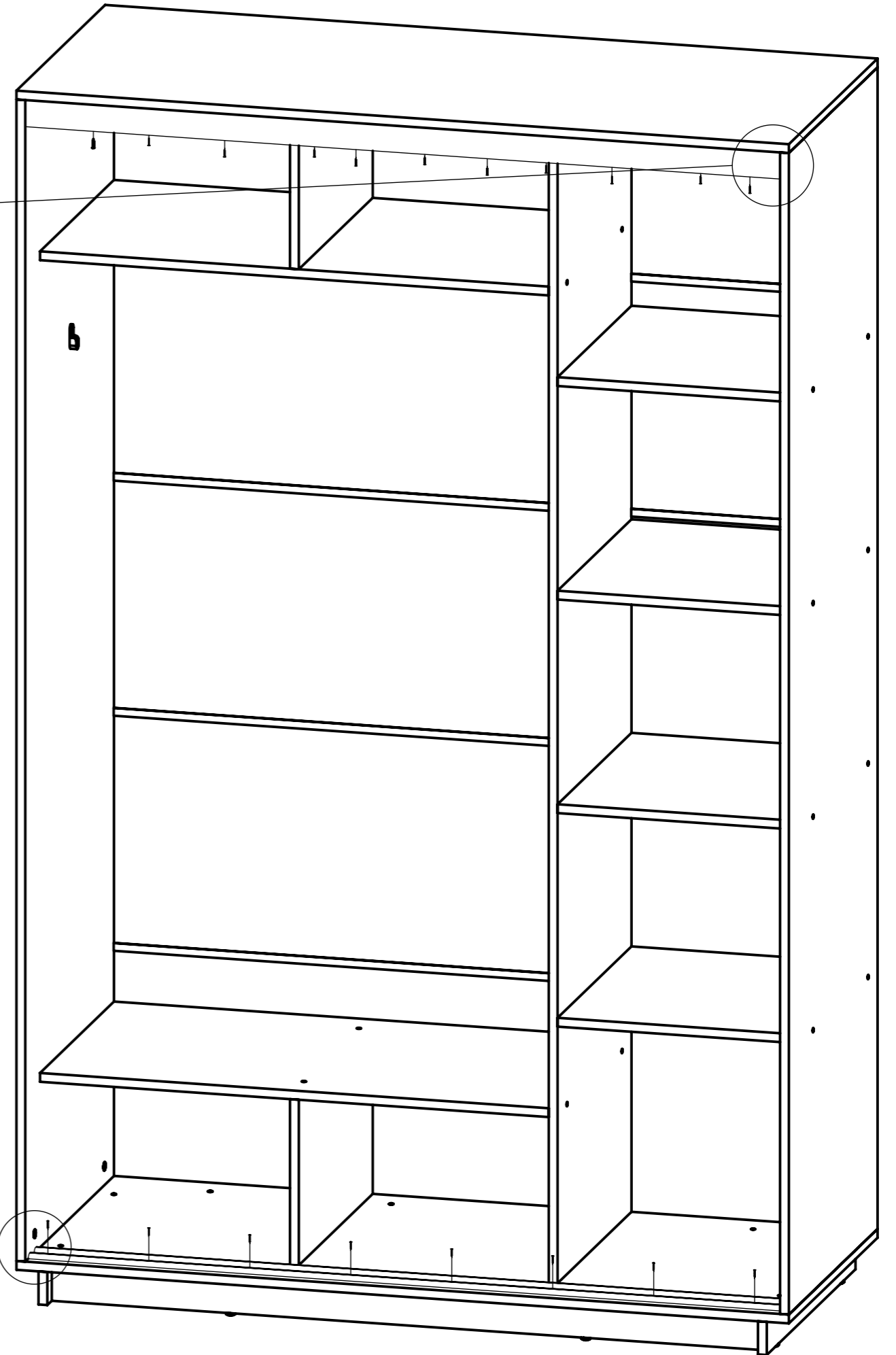
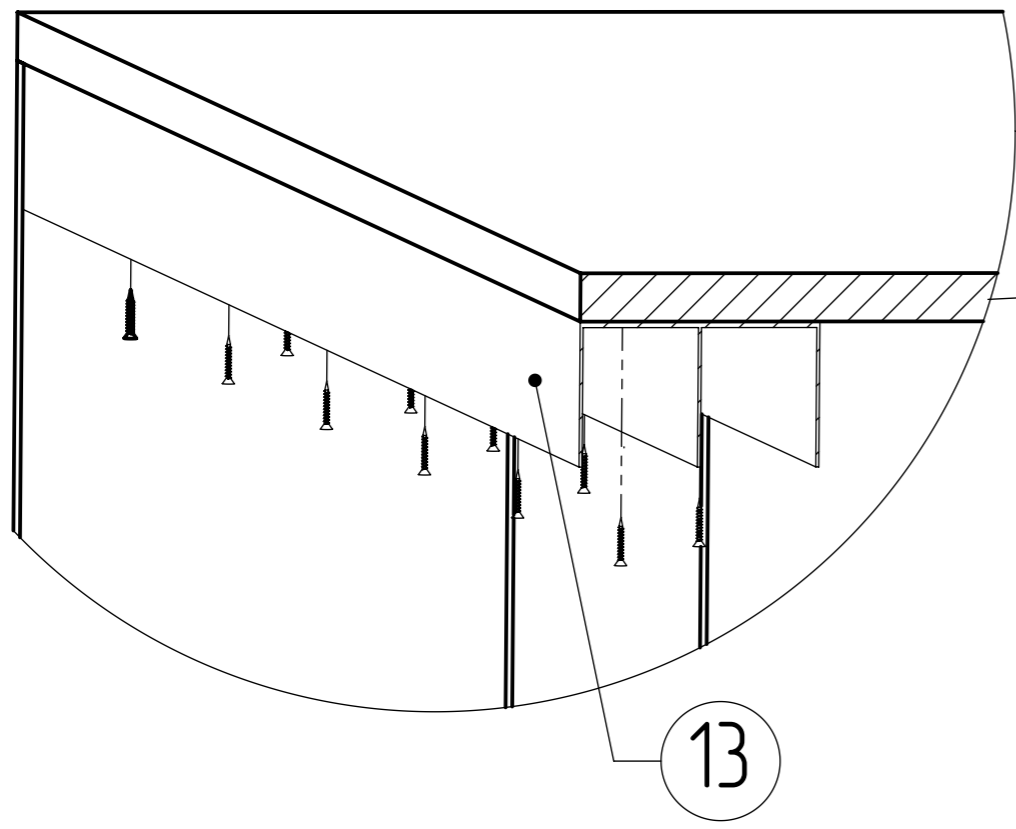

12

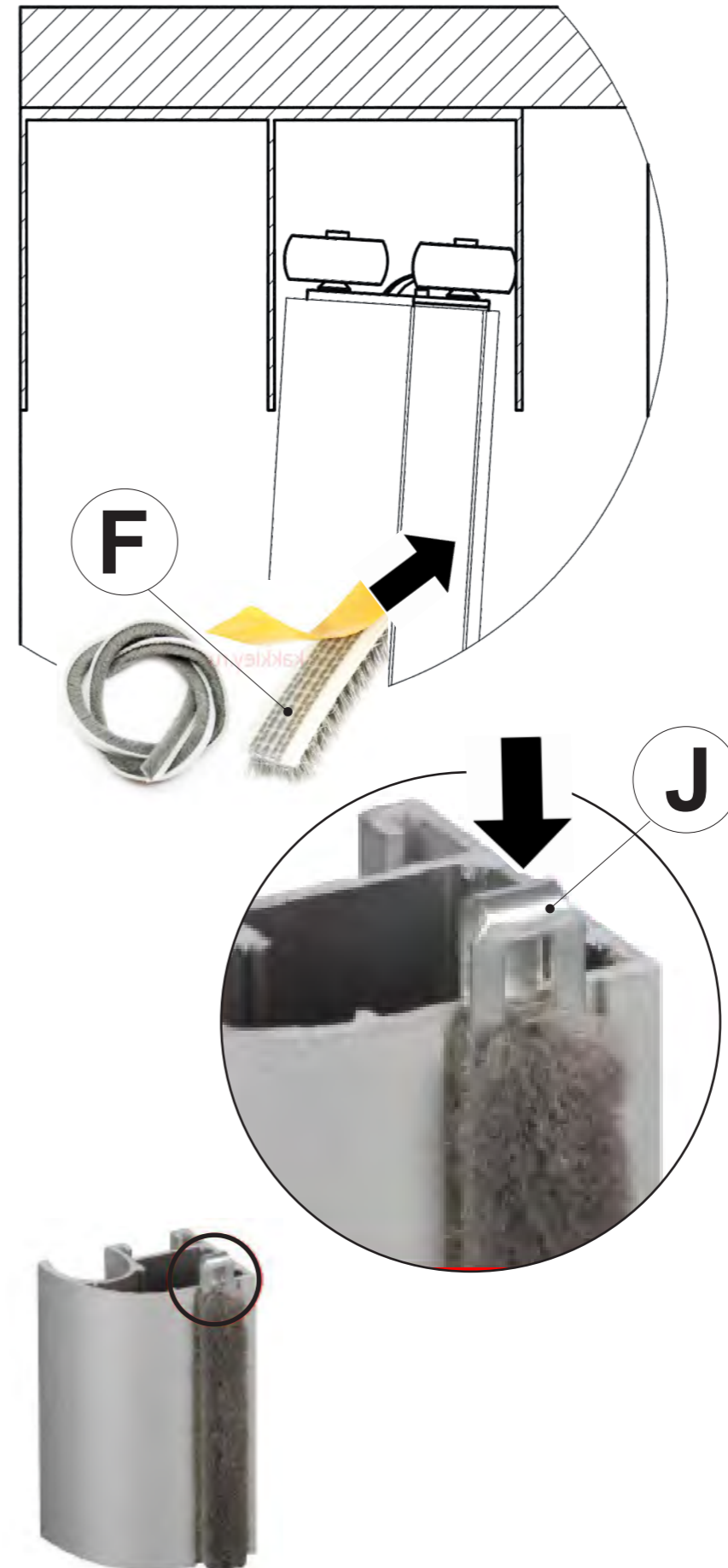
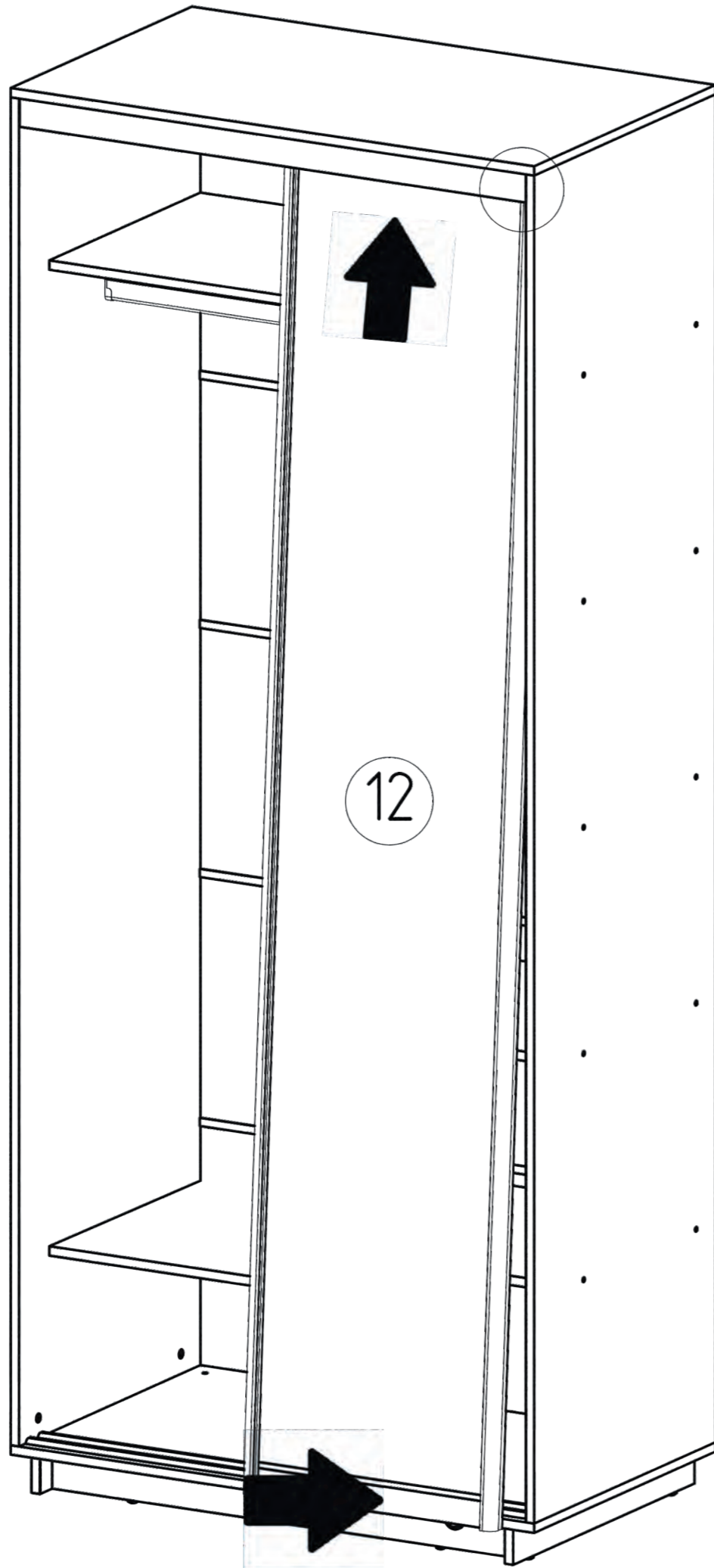

13

