

ASSEMBLY  
INSTRUCTIONS

247-000005

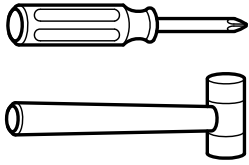

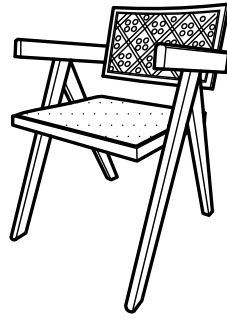

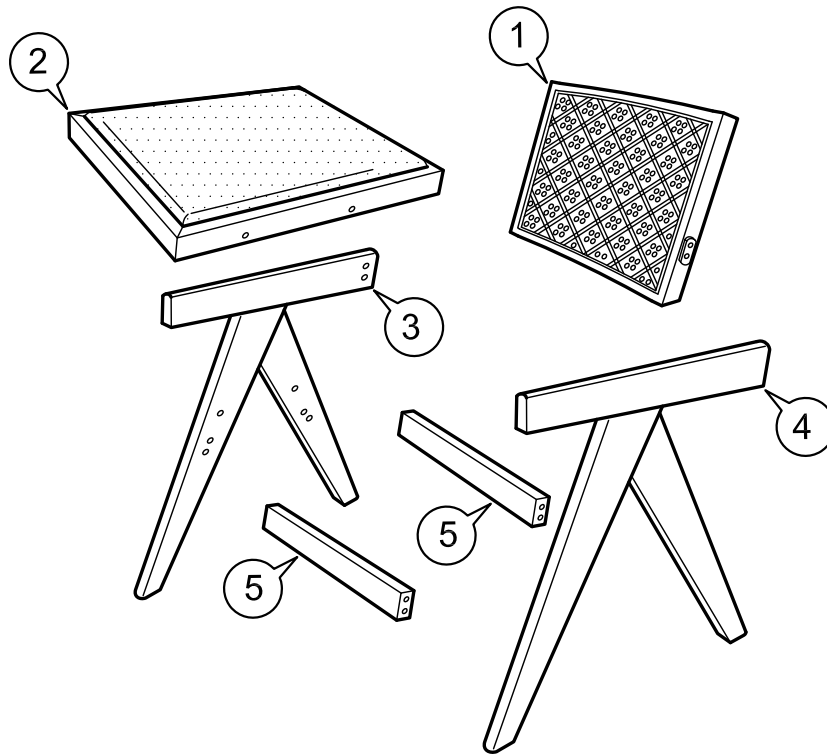

Not Provided

Part List :

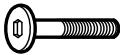

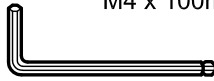
HARDWARE LIST :

<p>A M6 x 50mm = 24</p> 	<p>C M6 x 13mm = 16</p> 	<p>E M4 x 100mm = 1</p> 
<p>B 5/16" = 8</p> 	<p>D M8 x 30mm = 8</p> 	

1

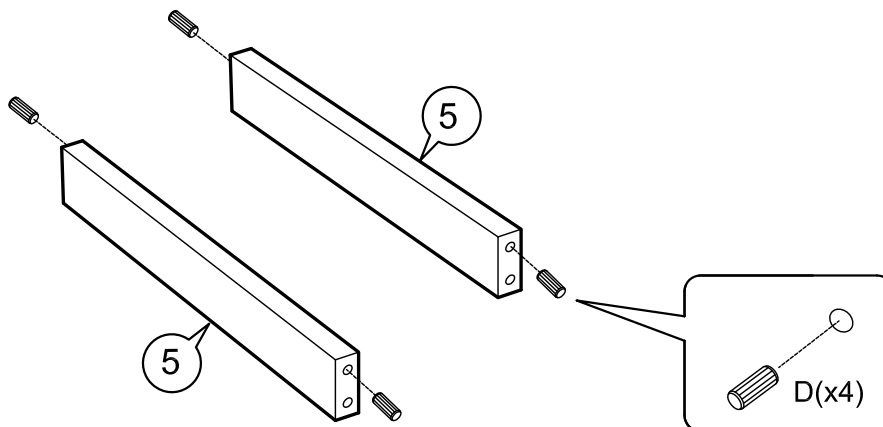

(x2)

2

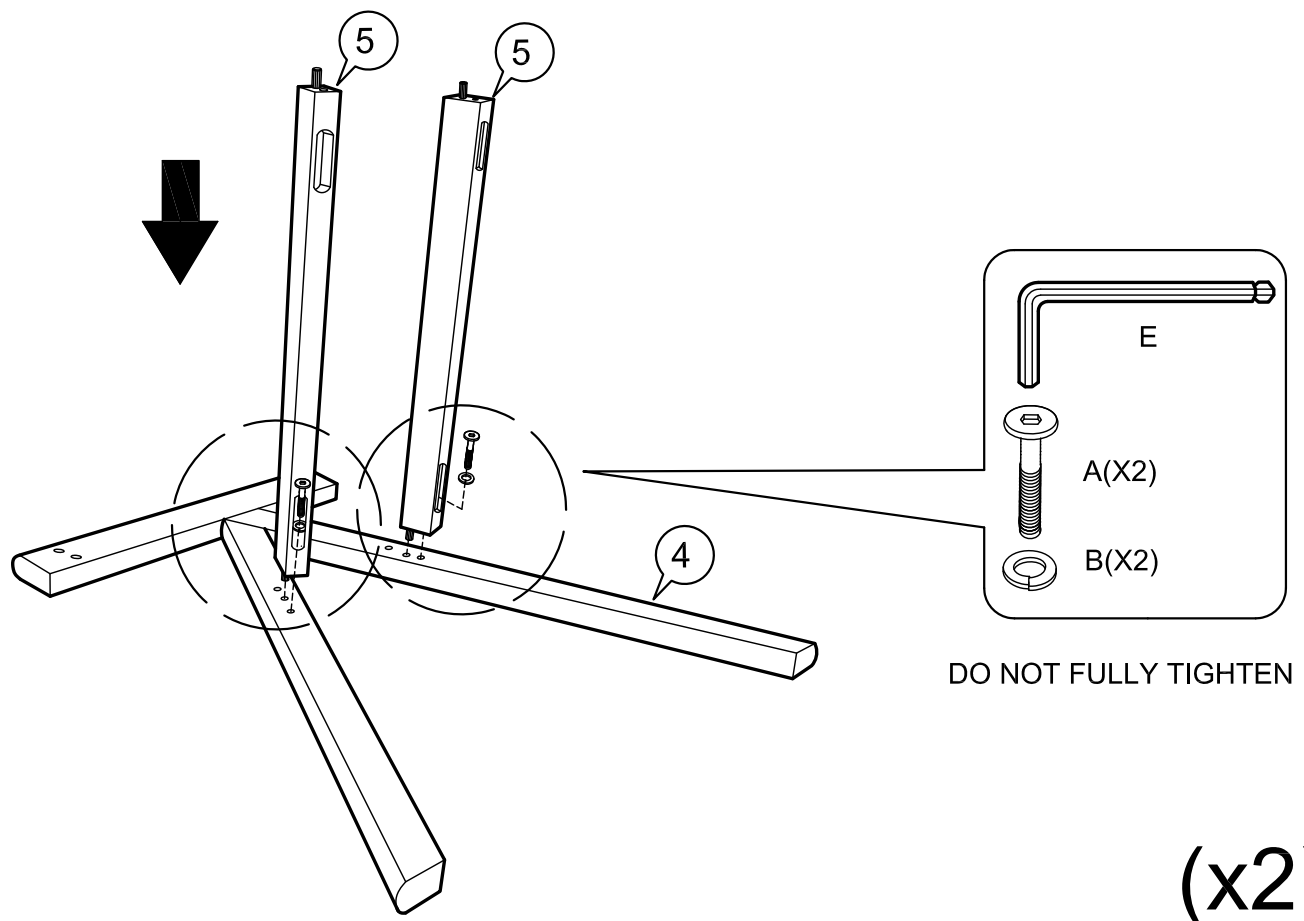

(x2)

3

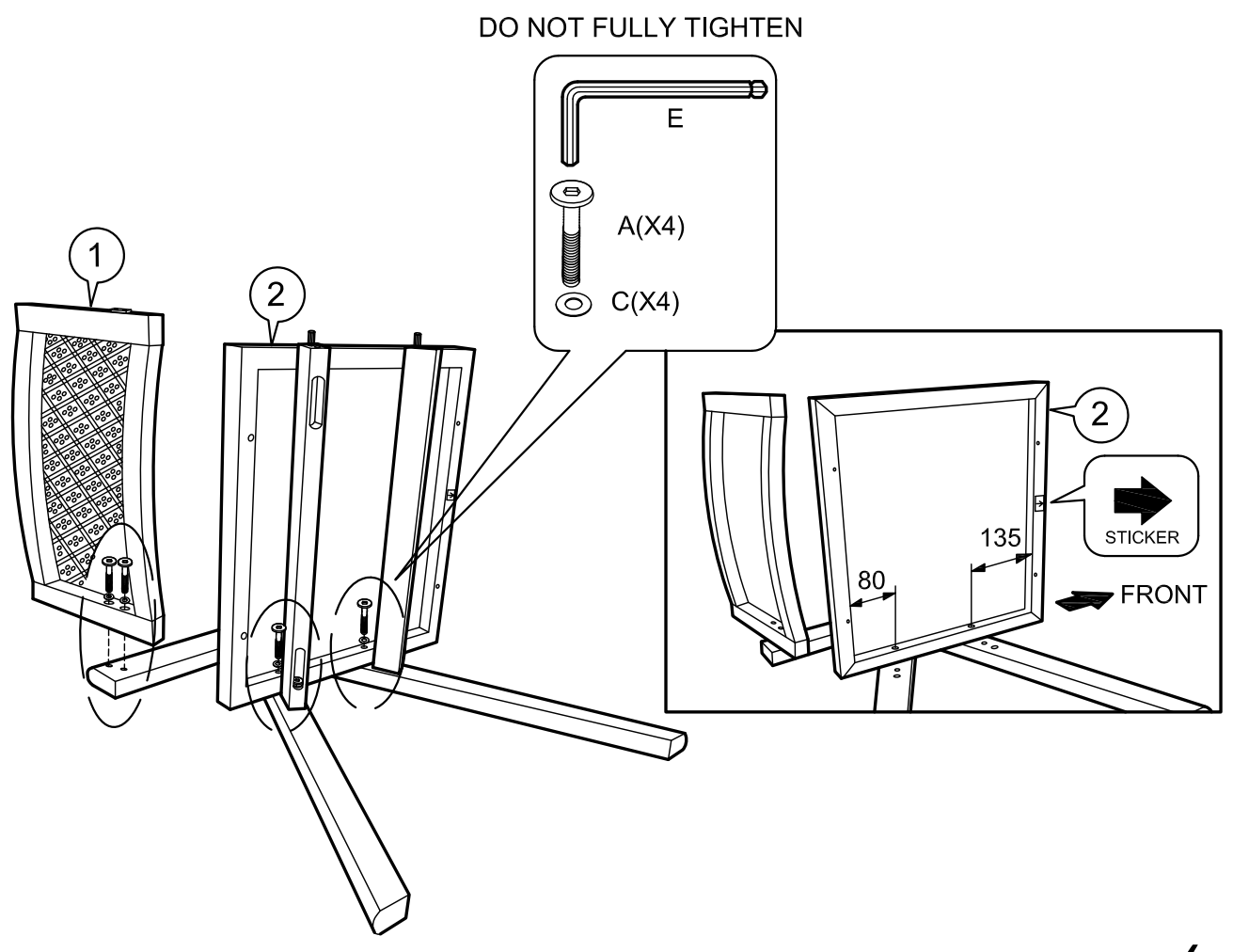

(x2)

4

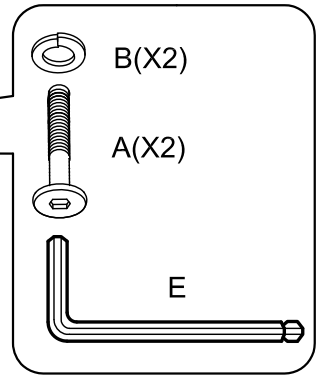
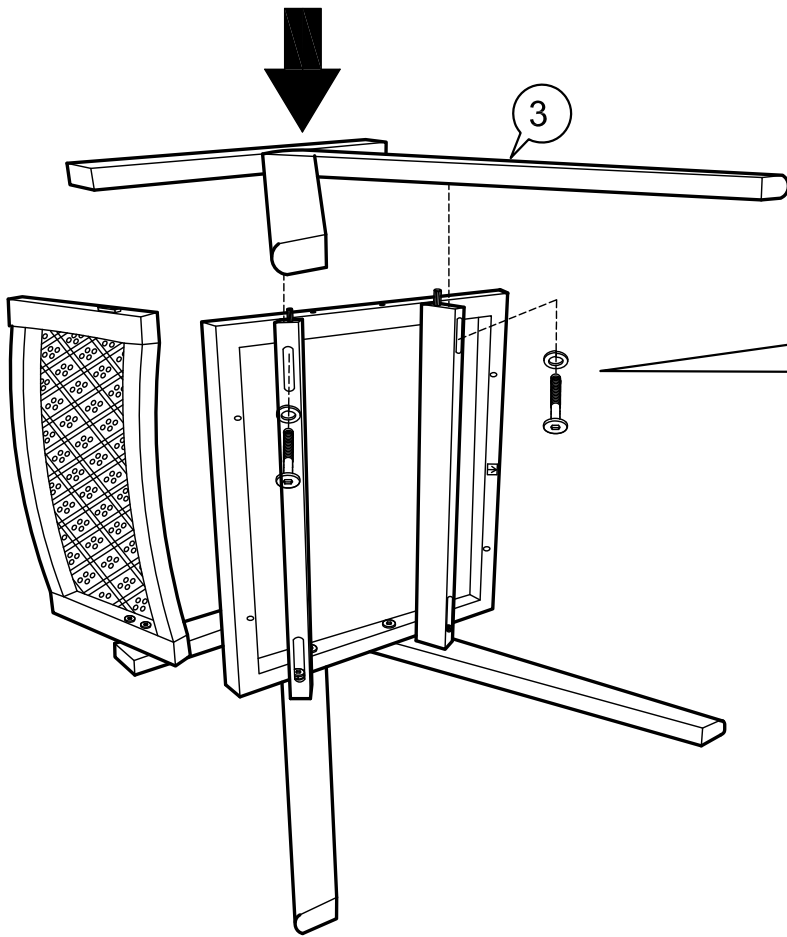

DO NOT FULLY TIGHTEN

(x2)

5

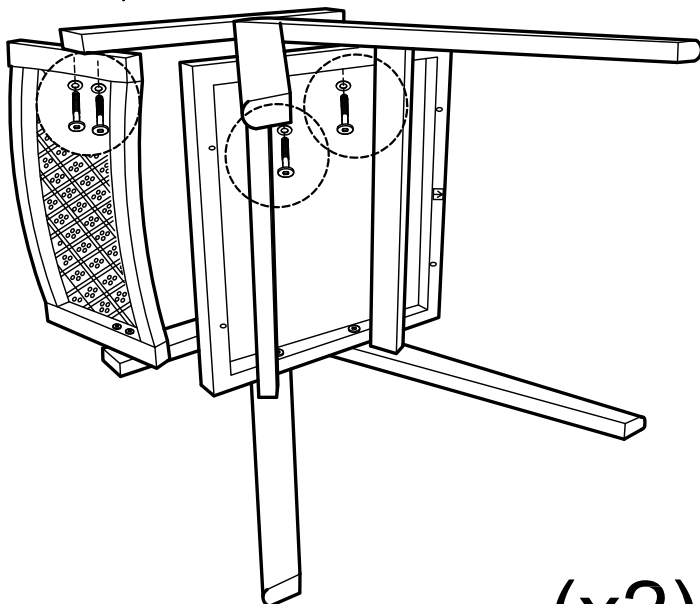
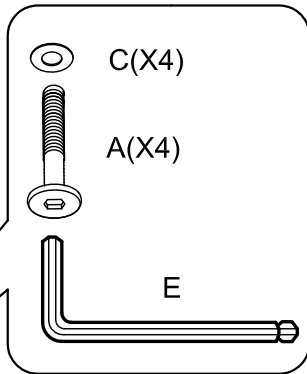

(x2)

6

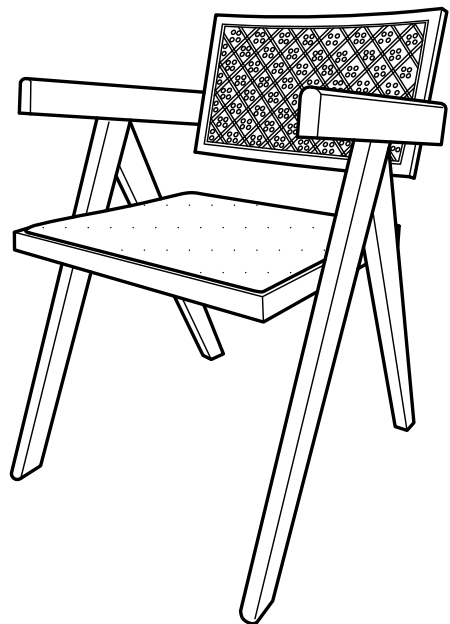

FULLY TIGHTEN ALL BOLTS

(x2)