

197-000188

Instruction Manual

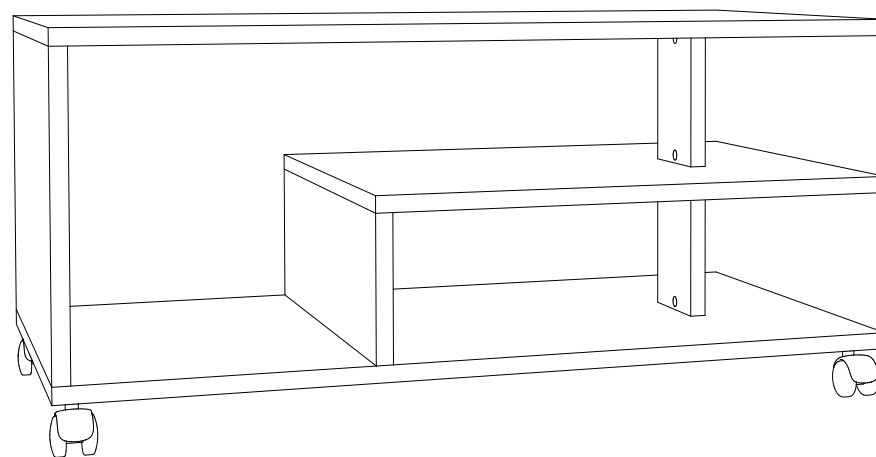

Σημαντική Ληροφορία
Διαβάστε προσεκτικά
Φυλάξτε αυτή την πληροφορία για μελλοντική
αναφορά.

GR ΠΡΟΕΙΔΟΠΟΙΗΣΗ

**Σοβαροί ή μοιραίοι τραυματισμοί από σύνθλιψη,
μπορεί να συμβούν από το αναποδογύρισμα
επιπίλου. Για να προλαμβάνεται το αναποδογύ-
ρισμα ενός επιπίλου, αυτό θα πρέπει να είναι
μόνιμα στερεωμένο στον τοίχο.**

Τα εξαρτήματα στερέωσης στον τοίχο δεν περιλαμ-
βάνονται, δεδομένου ότι τα διαφορετικά υλικά τοίχων
απαιτούν και διαφορετικούς τύπους εξαρτημάτων
στερέωσης. Χρησιμοποιήστε εξαρτήματα στερέωσης
κατάλληλα για τους τοίχους του σπιτιού σας. Για
πληροφορίες σχετικά με τα κατάλληλα εξαρτήματα
στερέωσης, συμβουλευθείτε το ειδικό κατάστημα της
περιοχής σας.

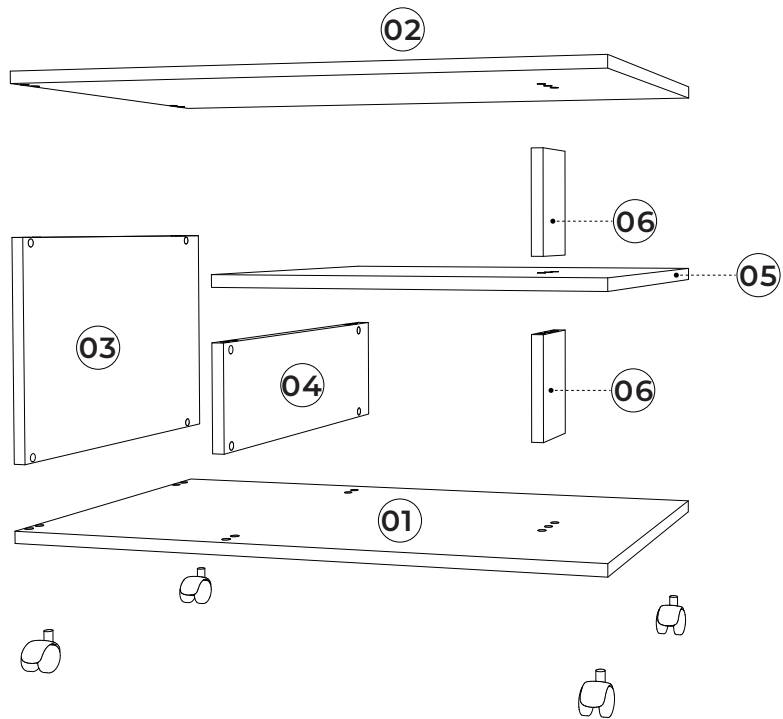

A01 *14 mm 12x	A02 *5x45 mm 10x	A60 *5x68 mm 1x
A03 *8x30 mm 16x	A04 12x	A71 4x
A09 *3,5x18 mm 16x		

01	900 x 500 mm
02	900 x 500 mm
03	335 x 498 mm
04	159 x 498 mm
05	500 x 500 mm
06	158 x 120 mm



Important information
Read carefully.
Keep this information for further reference.

GB WARNING

Serious or fatal crushing injuries can occur from furniture tip-over. To prevent this furniture from tipping over it must be permanently fixed to the wall.

Fixing devices for the wall are not included since different wall materials require different types of fixing devices. Use fixing devices suitable for the walls in your home. For advice on suitable fixing systems, contact your local specialized dealer.

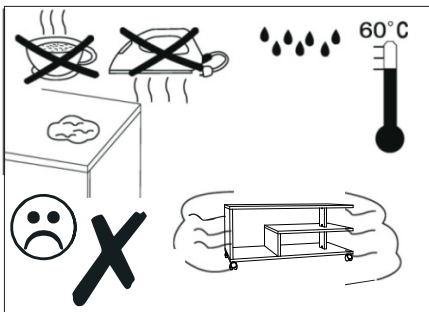
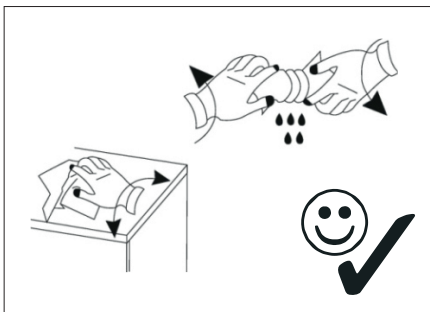
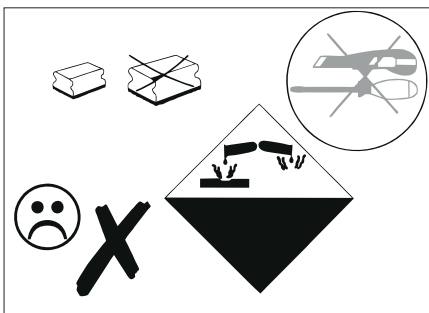
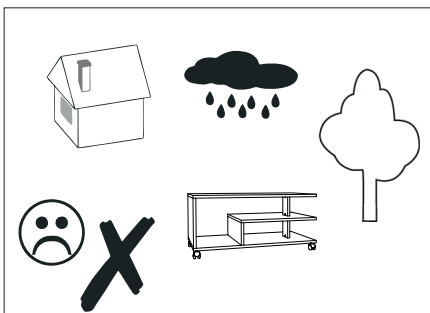
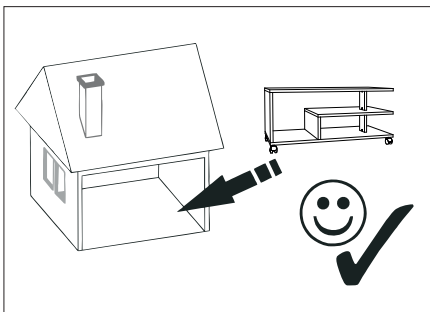

1.

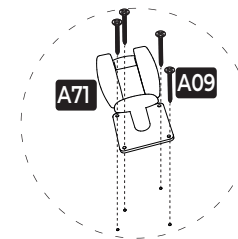
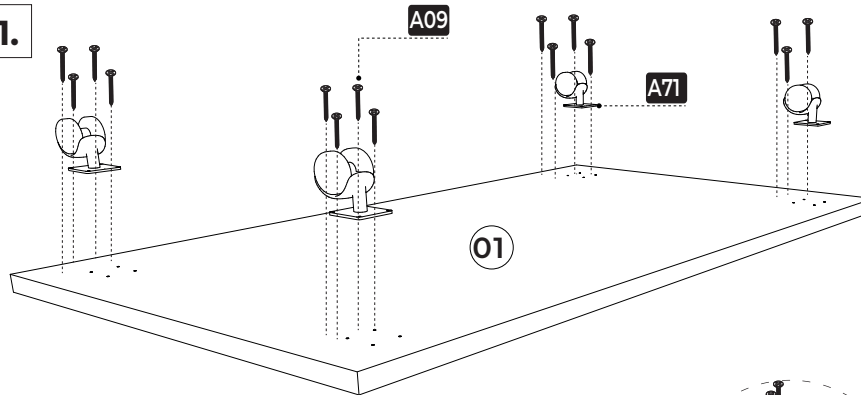

2.

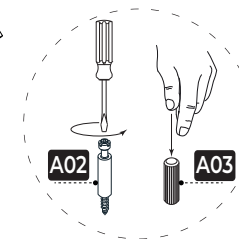
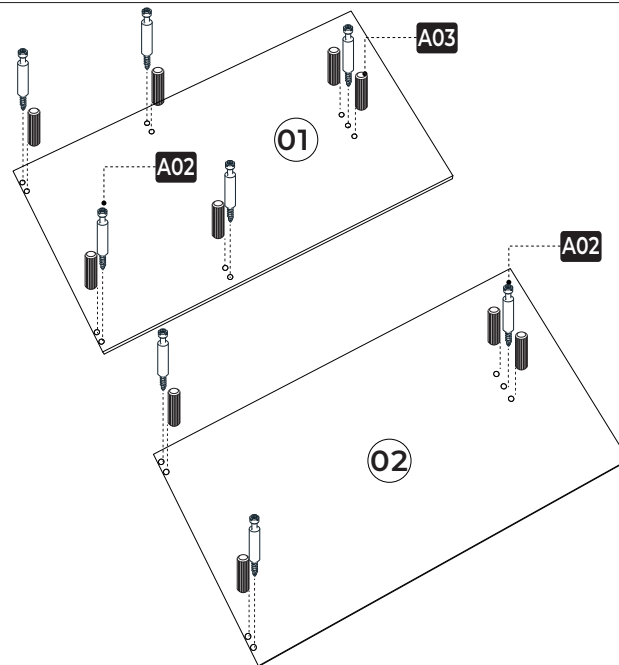

3.

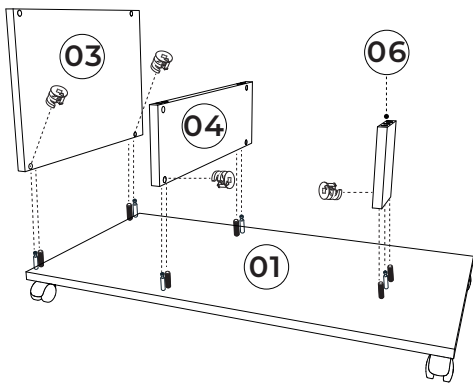

4.

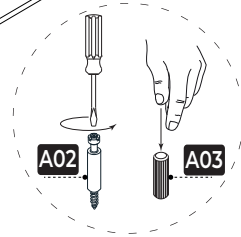
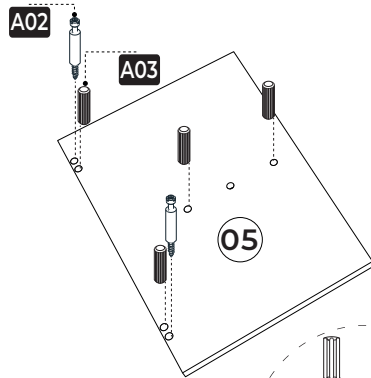

5.

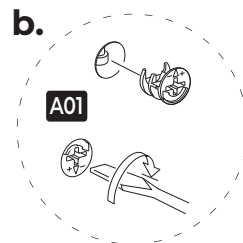
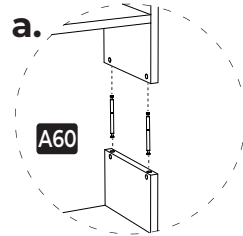
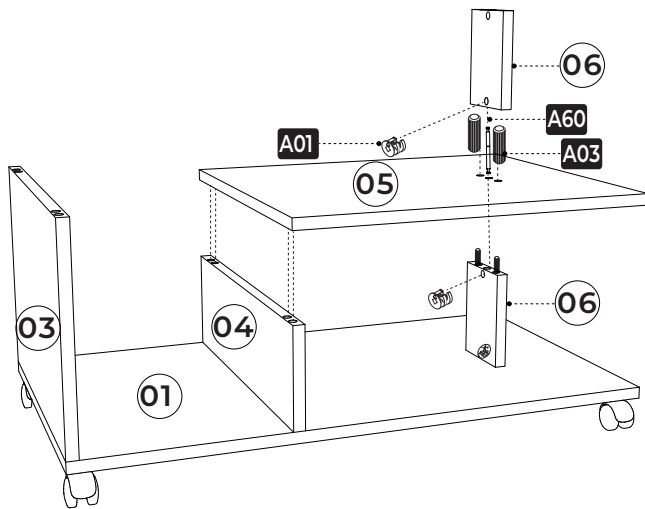

6.

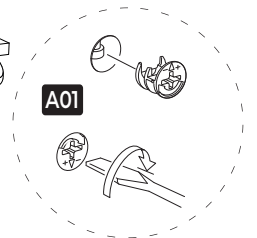
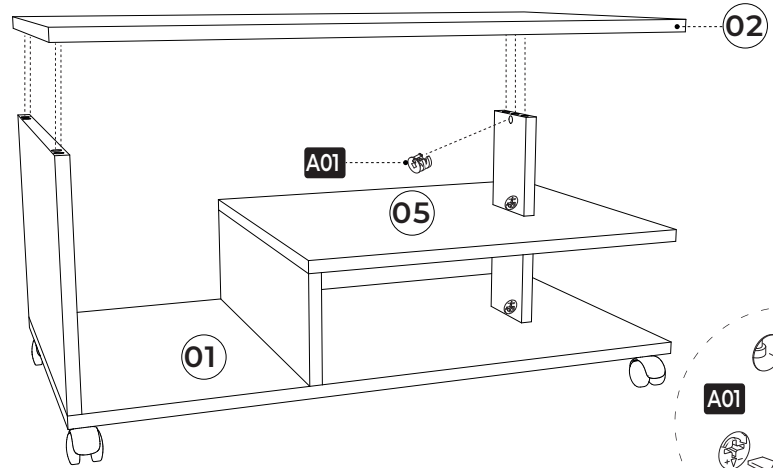

7.

